



**Radium**  
Die Lichtmarke

**LED  
Strips**

Flexible, customized,  
future-proof.

**Your light solution for creative  
and sustainable lighting.**

[www.radium.de/en/led-strips](http://www.radium.de/en/led-strips)



# Source of Inspiration for Every Project. **Radium Lighting Systems.**

## Flexible linear lighting systems

Linear lighting systems play an increasingly important role in modern lighting. The seamless light lines open up extremely versatile designs due to the variable adaptation to a wide variety of application areas. In addition, LED strips are significantly more efficient than fluorescent lamps and neon tubes and reduce energy and maintenance costs sustainably.

Get to know the Radium LED Strip systems and let the excellent quality of our products convince you!

## Efficient Allrounders

Radium LED Strips will enable you staging your rooms optimally. As effective direct lighting, they elegantly provide uniform, high-quality light. By means of indirect lighting, the LED strips set decorative highlights and create a cozy atmosphere. Radium LED Strips do not only convince indoors, but also in outdoor applications: thanks to their protection class, our robust, waterproof LED strips also demonstrate durability and reliable functionality outdoors. With the accompanying wide range of accessories, the lighting systems can be optimally accommodated to the application and easily installed. Whether LED strip, LED driver, aluminum profile, cover or mounting accessories – obtaining from us means: you get everything from one source.

### Application examples:

- Architectural lighting
- Department stores
- Hotels, restaurants, bars
- Meeting rooms, foyers, entrance halls
- Effective outdoor lighting

# Content

LED Strip Configurator	12
<b>LED Strips</b>	<b>18</b>
<b>Profiles and Covers</b>	<b>58</b>
<b>Power Supply</b>	<b>80</b>
<b>Light Control</b>	<b>88</b>
Technical Information	94
Pictograms	96

**„Flexible LED Strips  
from Radium are the  
perfect allround solution  
for modern lighting  
requirements.“**



# LED Strips for Future-proof Projects.

## Light in all its Facets.



### Eye-catcher by modern lighting design

Today, modern LED lighting does not just provide brightness, but also takes on a whole lot of other tasks. Pleasantly homogeneous light has an aesthetic effect and fills every room with life. Forming of shadows is deliberately reduced. This creates a particularly uniform lighting atmosphere. And thanks to luminaires becoming slimmer and slimmer light sources stay modestly in the background. Their simple yet stylish look is supported by modern aluminum profiles or whole LED luminaires which disappear completely into coves, between shelves or showcases.



### Form and functionality in harmony

With LED Strips from Radium you can design projects of all kinds individually and flexibly. Thanks to their compact design, you can also find space in slim luminaires or narrow coves. This freedom of design enables you to set up elegant systems that are easy to install and connect. For outdoor installations no special devices are required, but they are also open to creative solutions.



### Wide portfolio for versatile applications

Digital lighting is increasingly becoming a multifunctional design tool. Whether simple white lighting in different light colours or coloured light through RGB and RGBW technology, everything is possible. Tunable white and WarmDIM modules in combination with the appropriate light control create the perfect prerequisite for individual light colours with the best light quality. With a programmed course of daylight, the light can have an optimal effect on the human biorhythm. Solutions like this are used in Human Centric Lighting (HCL) concepts and thus make an important contribution to wellbeing, motivation and the ability to concentrate.

**Properly supplied – granted.**

In the Radium portfolio you will find the right LED drivers for optimal operation of the LED modules and smart lighting control for demanding projects

**Full focus on good lighting.**

You get matching plastic covers with a clear or matt surface for each profile. The professional covers do not only look good, they also ensure a fine light distribution with high efficiency.

**Design, protection and cooling.**

Our aluminum profiles are ideal for use with LED modules and offer a wide range of applications and design options.

**Brilliant light, efficient and versatile.**

The heart of the lighting solution is the LED module. Our broad portfolio does not leave anything to be desired for professional users. And in order to make the installation quick and easy, it would be best to order the fitting accessories in one go.







**Ceiling installation** for basic lighting and as stylish decorative lighting

# Design Advanced Rooms. By Targeted Use of LED Strips.



**Ceiling covers** for indirect lighting



**Back-lighting** for decorative accentuation



**Back-lighting** for accentuation or for advertising purposes



**Cabinet / Showcase lighting** for decorative accentuation



**Under-surface lighting** for decorative accentuation



**Wall covers**  
for indirect lighting



**Wire suspension**  
for basic lighting



**Wall-attached mounting**  
for decorative lighting



**Under-surface lighting**  
for decorative accent lighting

**Orientation light** for decorative and  
functional lighting in one go

Plan Ahead, Implement Efficiently.

## LED Strips as Full Reels or Tailor-made System.

Flexible LED Strips from Radium offer an extremely wide range of possible applications. But Radium also offers maximum flexibility in terms of scope of delivery to you: With either 5M Reels, 30M or 50M Big Reels and our customer-specific Individual Cut solutions, you are always well prepared for the wishes and requirements of your customers.

### LED Strips for every need

The portfolio of LED Star Strips makes each type available in three shipping options. In addition to our standard reels with 5 meters, you can also get extra long modules with up to 50 meters on a reel. When waterproof modules are needed, best let them be assembled by us, which saves time for you and you will get guaranteed quality directly from the manufacturer.

Use our online configurator for LED Strips to plan your projects at [www.radium.de/en/ledstrip](http://www.radium.de/en/ledstrip).

### Professional make-to-order and environmental protection

Would you like to reduce your assembly expenses? Then we would be happy to take care of the assembly of the components for you. Our employees will cut the LED strip, profile and cover according to your specifications. Every lighting system we assemble is subjected to a 100% final clearance. We calculate the cutting of the LED strip, profile and cover as well as the glueing-in of the strips as a package price. You can see the respective services on [page 11](#).

In the interest of environmental protection, we pack and ship the components with recyclable materials and try to do it without plastic if possible. So, even accessories such as mounting brackets and end caps are packed in paper bags.





**5M  
Reels**



Versatile, extremely energy-efficient and particularly long-lasting: Flexible LED strips are the clever all-round solution for a wide variety of lighting tasks today. So it's always good to have the fitting material in stock. With the high-quality 5M Reels from Radium, you can offer sophisticated customers the most modern LED technology for a wide range of applications. The standard market unit ensures both a lower storage risk and less tied-up capital and it also ensures high availability.

## Your advantages

### **5 meter reel**

- Customary units of measure
- Low storage risk and high availability



Big construction projects make you think big: You also need bigger numbers of LEDs, therefore, larger reels of LED Strips. With the 50 or 30 meters long Big Reels, Radium offers you the latest LED technology for a variety of tasks – from general lighting to accent lighting – so that you don't have to spend a long time searching for the best and most economical lighting solution. And that with little wiring and minimal waste. So you enjoy maximum flexibility on the construction site and are always ready for your next LED lighting project.

## Your advantages

### 50 or 30 meter reel

- Little waste
- Maximum operable length can be used without additional Strip to Strip connectors
- Saves space and packaging material

50/30M  
Big  
Reels





**Individual Cut**

**Service**

**SERVICE CUT STRIP**

- Cutting the LED Strip to size
- Soldering a cable

**SERVICE CUT PROFILE/COVER**

- Cutting the profile and cover

**SERVICE CUT STRIP/PROFILE/COVER**

- Cutting the LED Strip to size
- Soldering a cable
- Cutting the profile and cover

**SERVICE CUT AND MOUNT**

- Cutting the LED Strip to size
- Soldering a cable
- Cutting the profile and cover
- Mounting accessories and gluing in the LED Strip

Sometimes you just need tailor-made solutions that are a perfect fit for specific requirements. We manufacture flexible LED strips according to your individual length specifications. This enables you to plan important lighting projects particularly economically and precisely and then implement them extremely quickly on the construction site. Your personal contact at Radium will be happy to help you with your next lighting task.

**Your advantages**

**Make-to-order with Radium**

- Low installation effort
- Individual cuts
- Professional and ESD-protected processing
- 100% final inspection including functional test of the assembly

**Note:** The cable length is 0.5m as standard. Other lengths are available upon request.

Plan Projects Online.

## The LED Strip Configurator.

Use our online configurator when planning your lighting project with LED Strips! With this convenient tool, you can reach your target quickly and easily.

You enter the dimensions, the planned type of installation as well as light colour and brightness and we show you the corresponding products and compatible accessories.

Get a material list and ask us about the assembly. Let yourself be convinced by the LED Strip Configurator at [www.radium.de/en/ledstrip](http://www.radium.de/en/ledstrip).





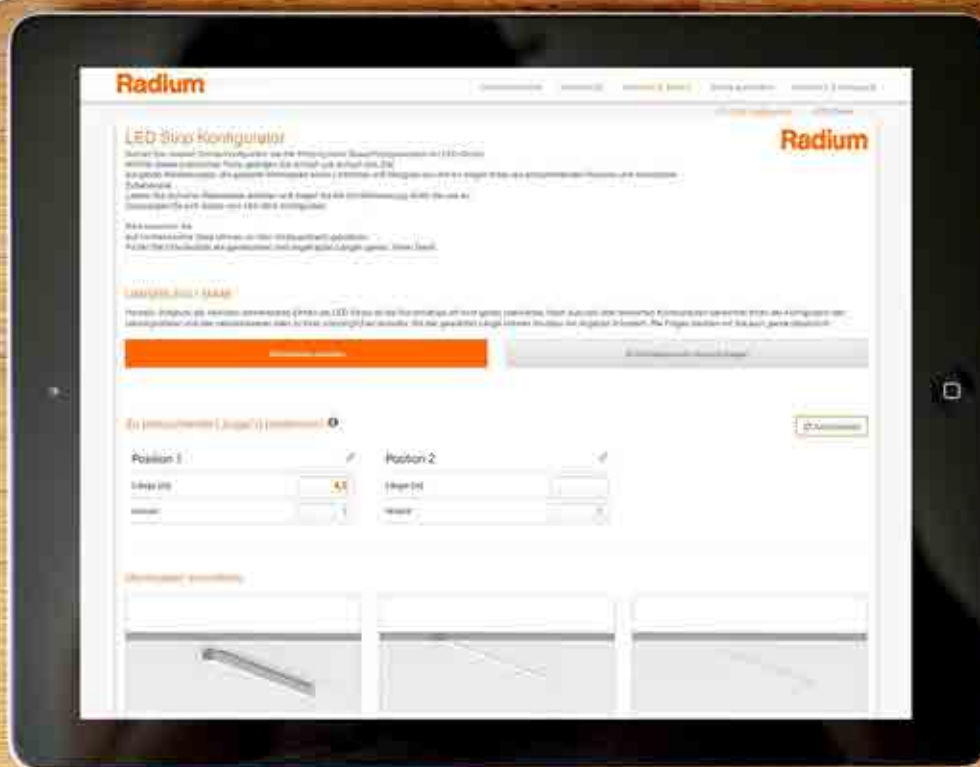

**„Efficient, flexible  
planning for your  
lighting project.  
It’s so easy with the  
Radium LED Strip  
Configurator. “**



# Innovative Lighting Design. **Realized with Radium.**

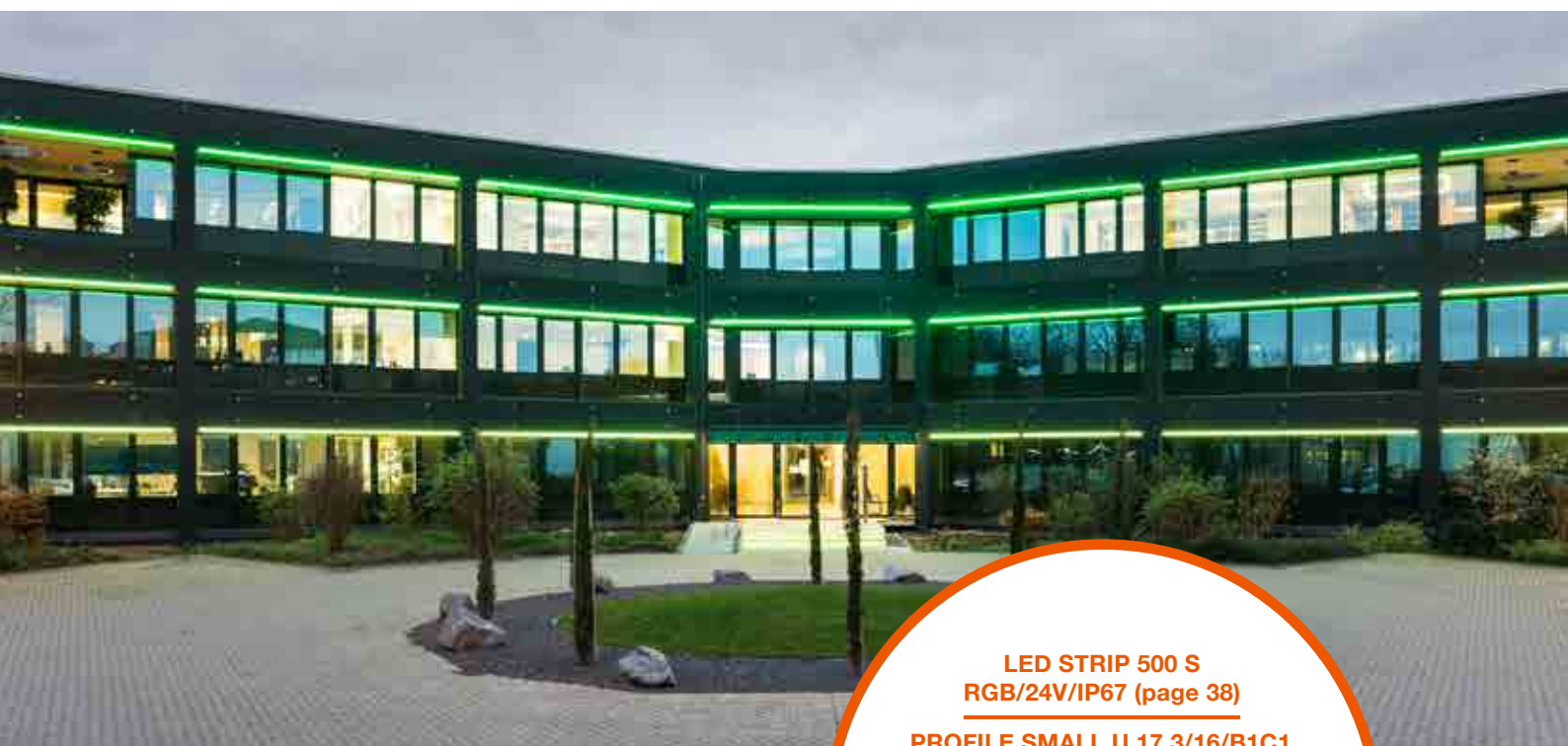

The exterior facade of the 'Green Building', an office building in Hanau, was highlighted in a spectacular light by means of waterproof RGB Strips. The strips were glued into a profile that was powder-coated in the colour of the building at the customer's request. Further, it was possible to attach it to the facade using specially manufactured mounting brackets. The lighting system is controlled via a complex DMX control system, with which each window section can be controlled individually and time-dependent scenes and sequences can be stored.

**LED STRIP 500 S**  
**RGB/24V/IP67 (page 38)**

**PROFILE SMALL U 17.3/16/B1C1**  
**(page 60-61)**

**COVER SMALL F 16.4/4/C1**  
**(page 75)**

**DRIVER DALI/DMX 4CH**  
**150W/24V IP20 (page 84)**

**Butler XT2 (Control gear)**

When planning the lighting of the foyer, focus was on homogeneity. Different coves in the entire entrance area of the office building ensure uniform illumination. The indirect lighting was generated by means of an angle profile including diffuse cover, which emits the light of the strips at a 45° angle and so provides for even better distribution in the room.

**LED STRIP 900 S**  
**930/24V (page 20)**

**PROFILE SMALL CORNER**  
**22.8/22.8/B1C1 (page 64–65)**

**COVER SMALL F 16.4/4/C1**  
**(page 75)**

**DRIVER FLAT 90W/24V IP20**  
**RADIUM (page 82)**





In the VIP area of Messe Düsseldorf, individually controllable accent lighting has been set up, which can be operated intuitively by using a smartphone or tablet. This project was implemented with RGB Strips that were mounted behind diffuse panes. The light lets the panes shine homogeneously in the programmed colours. Now, a Bluetooth Casambi controller makes it possible to store specific colours via password-protected access in order to highlight a customer event in the appropriate light.

**LED STRIP 500 S RGB/24V**  
[\(page 32\)](#)

**PROFILE SMALL U 17.3/16/B1C1**  
[\(page 60–61\)](#)

**COVER SMALL F 16.4/4/C1**  
[\(page 75\)](#)

**DRIVER FLAT 250W/24V IP20 RADIUM**  
[\(page 82\)](#)

**BCU PWM4/LR**  
[\(page 86\)](#)



**LED STRIP 2200 S 940/24V**  
**(page 22)**

**PROFILE MEDIUM WING 40/25.9/B2C2**  
**(page 72-73)**

**COVER MEDIUM F 26/5/C2**  
**(page 75)**

**DRIVER DALI/DMX 4CH**  
**150W/24V IP20 (page 84)**

Thanks to the linear lighting solution, the conference rooms at Messe Düsseldorf sparkle in a uniform light. At the same time, the bright light of the LED strips provides adequate basic lighting for the rooms. The lighting was installed using an aluminum installation profile that was inserted into the plasterboard ceiling using mounting springs. Due to the symmetrical, linear arrangement of the lighting system, an optically high-quality impression of the entire room is created.





Products.

## LED Strips.

Whether indoors or outdoors, whether for general or accent lighting, whether for small, medium or large lighting projects, whether Star or Essence: The flexible LED Strips from Radium are versatile, very durable and extremely energy-efficient. They convince both with high-quality materials and careful processing. And thanks to the small LED spacing, they ensure a homogeneous light distribution everywhere without creating shadows between the individual LEDs.

**Product highlights:**

- LED Star Strip ZeroPitch & ZeroPitch Furniture: [page 26](#)
- LED Star Strip Tunable White: [page 28](#)
- LED Star Strip WarmDIM: [page 30](#)
- LED Star Strip RGB and RGBW: [page 32](#)

14:22

**Star**

Optimal function for professional use.

**Essence**

Pure function at the best price.



# Content

LED Star Strip 400, 900, 1400, 2200 and 3000	20
LED Star Strip ZeroPitch and ZeroPitch Furniture	26
LED Star Strip Tunable White	28
LED Star Strip WarmDIM	30
LED Star Strip RGB and RGBW	32
LED Star Strip 400, 800, 1300 and 2000 Waterproof	34
LED Star Strip RGB Waterproof	38
LED Essence Strip 500, 1000 and 1500	40
LED Essence Strip ZeroPitch	44
LED Essence Strip RGBW and Tunable White	46
LED Essence Strip 400, 1000 and 1400 Waterproof	48
LED Essence Strip RGBW Waterproof	52
Accessories	54
Compatibility of Accessories	56

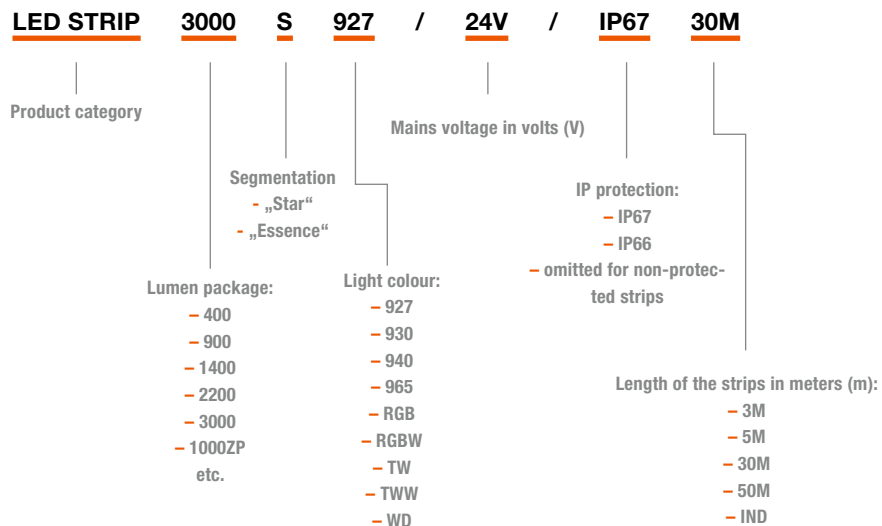

# LED Star Strip 400 and 900



## Product features:

- Very long lifespan: **60,000 h L80B50**
- Very good colour rendering: **CRI >90**
- Suitable for operation on **24 V DC**
- High colour consistency: **SDCM <3**
- Very high efficiency of up to **162 lm/W**

## Advantages:

- Long max. operable length: up to 18 m, without loss of luminous flux thanks to IC and high copper content in PCB
- Centimeter scale on the LED strip
- Particularly large soldering pads
- Homogeneous light with up to **160 LEDs per meter**



## LED Star Strip 400

							mm		pcs.	
1	RSTA4585	<b>LED STRIP 400 S 927/24V 5M</b>	2.8	415	80	●	12.5	D	2	10
1	RSTA4595	<b>LED STRIP 400 S 930/24V 5M</b>	2.8	430	80	●	12.5	D	2	10
1	RSTA4605	<b>LED STRIP 400 S 940/24V 5M</b>	2.8	450	80	○	12.5	D	2	10
1	RSTA4615	<b>LED STRIP 400 S 965/24V 5M*</b>	2.8	445	80	●	12.5	D	2	10

## LED Star Strip 900

2	RSTA4625	<b>LED STRIP 900 S 927/24V 5M</b>	5.6	840	160	●	6.3	D	2	10
2	RSTA4635	<b>LED STRIP 900 S 930/24V 5M</b>	5.6	870	160	●	6.3	D	2	10
2	RSTA4645	<b>LED STRIP 900 S 940/24V 5M</b>	5.6	915	160	○	6.3	D	2	10
2	RSTA4655	<b>LED STRIP 900 S 965/24V 5M*</b>	5.6	905	160	●	6.3	D	2	10

\* LED strips with color temperature 6500 K available on request, only.

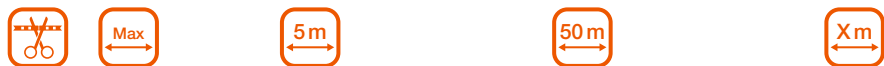

## Available lengths

		mm	m	article no.	article no.	article no.
1	<b>LED STRIP 400 S 927/24V</b>	100	18	RSTA4585	RSTA4580	RSTA4581
1	<b>LED STRIP 400 S 930/24V</b>	100	18	RSTA4595	RSTA4590	RSTA4591
1	<b>LED STRIP 400 S 940/24V</b>	100	18	RSTA4605	RSTA4600	RSTA4601
1	<b>LED STRIP 400 S 965/24V*</b>	100	18	RSTA4615	RSTA4610	RSTA4611
2	<b>LED STRIP 900 S 927/24V</b>	50	13	RSTA4625	RSTA4620	RSTA4621
2	<b>LED STRIP 900 S 930/24V</b>	50	13	RSTA4635	RSTA4630	RSTA4631
2	<b>LED STRIP 900 S 940/24V</b>	50	13	RSTA4645	RSTA4640	RSTA4641
2	<b>LED STRIP 900 S 965/24V*</b>	50	13	RSTA4655	RSTA4650	RSTA4651

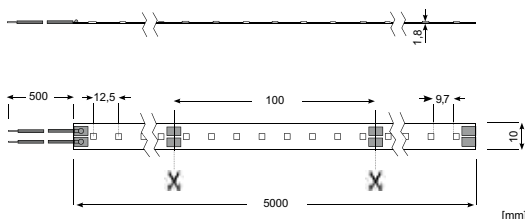

1

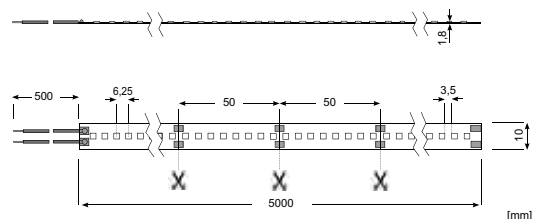

2



## Feed-in connector for LED Strips

**STRIP CON**  
2PIN 10MM/50CM  
FXZA4461



## Strip-to-Strip connector

**STRIP CABLE BRIDGE**  
2PIN 10MM/5CM 4PCS  
FXZA4510



Please refer to [page 54](#) for further product information.

## Profiles

**PROFILE SMALL U FLAT**  
17.3/9.6/B1C1 1M  
TRPA2511

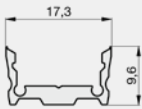

**PROFILE SMALL U**  
17.3/16/B1C1 1M  
TRPA2501

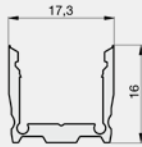

**PROFILE SMALL WING**  
25/13/B1C1 1M  
TRPA2521

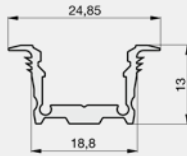

**PROFILE SMALL CORNER**  
22.8/22.8/B1C1 1M  
TRPA2531

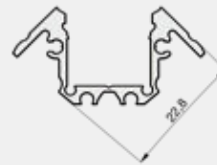

## Covers

**COVER SMALL F**  
16.4/4/C1 1M  
ZTPA2571

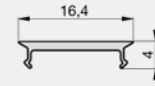

**COVER SMALL SQUARE**  
17/9/C1 1M  
ZTPA3111

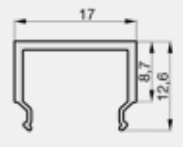

**PROFILE MEDIUM U FLAT**  
27/10.2/B2C2 1M  
TRPA2551

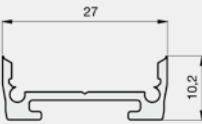

**PROFILE MEDIUM U**  
27/25.9/B2C2 1M  
TRPA2541

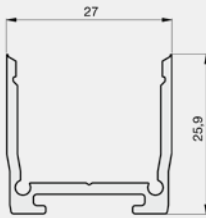

**PROFILE MEDIUM WING**  
40/25.9/B2C2 1M  
TRPA2561

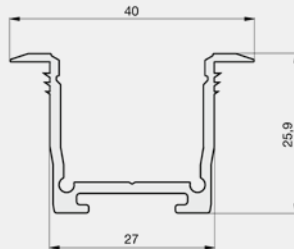

**COVER MEDIUM F**  
26/5/C2 1M  
ZTPA2591

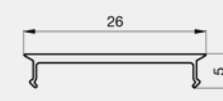

**COVER MEDIUM SQUARE**  
27/14/C2 1M  
ZTPA3121

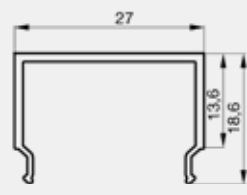

Please find further profiles, covers and accessories as well as product information on [page 58 ff.](#)

## Power Supply

**Not dimmable**  
**DRIVER FLAT 36W/24V**  
IP20 RADIUM  
OTNA3102



**Dimmable Phasecut**  
**DRIVER PHASECUT 36W/24V**  
IP20 RADIUM  
OTDA4077



**Dimmable DALI**  
**DRIVER DALI 1CH 36W/24V**  
IP20 RADIUM  
OTDA4070



**Dimmable Casambi (Bluetooth)**  
**DRIVER BT 1CH 35W/24V**  
IP20  
OTDA2443



**LED Star Strip 400** 12.8 m  
**LED Star Strip 900** 6.4 m



**LED Star Strip 400** 12.8 m  
**LED Star Strip 900** 6.4 m



**LED Star Strip 400** 12.8 m  
**LED Star Strip 900** 6.4 m



**LED Star Strip 400** 12.5 m  
**LED Star Strip 900** 6.2 m



Please refer to [page 80 ff.](#) for further information on control gears, dimmers and accessories.

Please refer to [page 88 ff.](#) for further information on control units.

# LED Star Strip 1400 and 2200



## Product features:

- Very long lifespan: **60,000 h L80B50**
- Very good colour rendering: **CRI >90**
- Suitable for operation on **24 V DC**
- High colour consistency: **SDCM <3**
- Very high efficiency of up to **164 lm/W**

## Advantages:

- Long max. operable length without loss of luminous flux thanks to IC and high copper content in PCB
- Centimeter scale on the LED strip
- Particularly large soldering pads
- Homogeneous light with **160 LEDs per meter**



1



## LED Star Strip 1400

							mm		pcs.	
1	RSTA4665	<b>LED STRIP 1400 S 927/24V 5M</b>	9.0	1375	160	●	6.3	D	2	10
1	RSTA4675	<b>LED STRIP 1400 S 930/24V 5M</b>	9.0	1420	160	●	6.3	D	2	10
1	RSTA4685	<b>LED STRIP 1400 S 940/24V 5M</b>	9.0	1490	160	○	6.3	D	2	10
1	RSTA4695	<b>LED STRIP 1400 S 965/24V 5M*</b>	9.0	1475	160	●	6.3	D	2	10

## LED Star Strip 2200

1	RSTA4705	<b>LED STRIP 2200 S 927/24V 5M</b>	14	2100	160	●	6.3	D	2	10
1	RSTA4715	<b>LED STRIP 2200 S 930/24V 5M</b>	14	2150	160	●	6.3	D	2	10
1	RSTA4725	<b>LED STRIP 2200 S 940/24V 5M</b>	14	2250	160	○	6.3	D	2	10
1	RSTA4735	<b>LED STRIP 2200 S 965/24V 5M*</b>	14	2230	160	●	6.3	D	2	10

**Note:** For appropriate operation of the LED Strip, an aluminum profile is required for cooling.

\* LED strips with color temperature 6500 K available on request, only.



## Available lengths

		mm	m	article no.	article no.	article no.
1	<b>LED STRIP 1400 S 927/24V</b>	50	10	RSTA4665	RSTA4660	RSTA4661
1	<b>LED STRIP 1400 S 930/24V</b>	50	10	RSTA4675	RSTA4670	RSTA4671
1	<b>LED STRIP 1400 S 940/24V</b>	50	10	RSTA4685	RSTA4680	RSTA4681
1	<b>LED STRIP 1400 S 965/24V*</b>	50	10	RSTA4695	RSTA4690	RSTA4691
1	<b>LED STRIP 2200 S 927/24V</b>	50	7	RSTA4705	RSTA4700	RSTA4701
1	<b>LED STRIP 2200 S 930/24V</b>	50	7	RSTA4715	RSTA4710	RSTA4711
1	<b>LED STRIP 2200 S 940/24V</b>	50	7	RSTA4725	RSTA4720	RSTA4721
1	<b>LED STRIP 2200 S 965/24V*</b>	50	7	RSTA4735	RSTA4730	RSTA4731

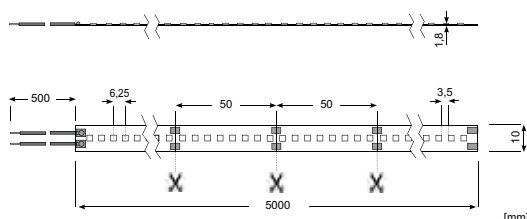

1

## Feed-in connector for LED Strips

**STRIP CON**  
2PIN 10MM/50CM  
FXZA4461



## Strip to strip connector

**STRIP CABLE BRIDGE**  
2PIN 10MM/5CM 4PCS  
FXZA4510

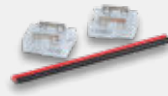

Please refer to [page 54](#) for further product information.

## Profiles

**PROFILE SMALL U FLAT**  
17.3/9.6/B1C1 1M  
TRPA2511

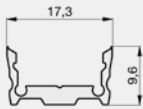

**PROFILE SMALL U**  
17.3/16/B1C1 1M  
TRPA2501

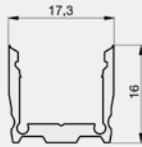

**PROFILE SMALL WING**  
25/13/B1C1 1M  
TRPA2521

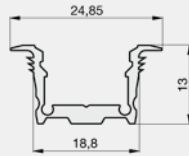

**PROFILE SMALL CORNER**  
22.8/22.8/B1C1 1M  
TRPA2531

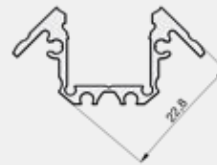

## Covers

**COVER SMALL F**  
16.4/4/C1 1M  
ZTPA2571

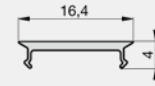

**COVER SMALL SQUARE**  
17/9/C1 1M  
ZTPA3111

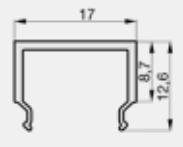

**PROFILE MEDIUM U FLAT**  
27/10.2/B2C2 1M  
TRPA2551

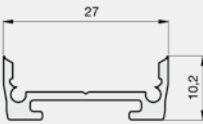

**PROFILE MEDIUM U**  
27/25.9/B2C2 1M  
TRPA2541

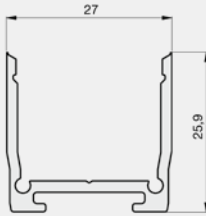

**PROFILE MEDIUM WING**  
40/25.9/B2C2 1M  
TRPA2561

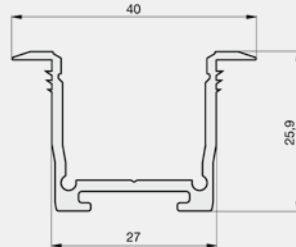

**COVER MEDIUM F**  
26/5/C2 1M  
ZTPA2591

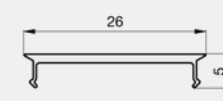

**COVER MEDIUM SQUARE**  
27/14/C2 1M  
ZTPA3121

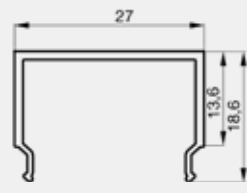

Please find further profiles, covers and accessories as well as product information on [page 58 ff.](#)

## Power Supply

**Not dimmable**  
**DRIVER FLAT 60W/24V**  
IP20 RADIUM  
OTNA3103



**Dimmable Phasecut**  
**DRIVER PHASECUT 75W/24V**  
IP20 RADIUM  
OTDA3026



**Dimmable DALI**  
**DRIVER DALI 1CH 75W/24V**  
IP20 RADIUM  
OTDA4071



**Dimmable Casambi (Bluetooth)**  
**DRIVER BT 1CH 60W/24V**  
IP20  
OTDA2444



**LED Star Strip 1400** 6.6m  
**LED Star Strip 2200** 4.2m



**LED Star Strip 1400** 8.3m  
**LED Star Strip 2200** 5.3m



**LED Star Strip 1400** 8.3m  
**LED Star Strip 2200** 5.3m



**LED Star Strip 1400** 6.6m  
**LED Star Strip 2200** 4.2m



Please refer to [page 80 ff.](#) for further information on control gears, dimmers and accessories.

Please refer to [page 88 ff.](#) for further information on control units.

# LED Star Strip 3000



## Product features:

- Very long lifespan: **60,000 h L80B50**
- Very good colour rendering: **CRI >90**
- Suitable for operation on **24 V DC**
- High colour consistency: **SDCM <3**
- High efficiency of up to **160 lm/W**

## Advantages:

- Long max. operable length without loss of luminous flux thanks to IC and high copper content in PCB
- Centimeter scale on the LED strip
- Particularly large soldering pads
- Homogeneous light with **160 LEDs per meter**



## LED Star Strip 3000

							mm		pcs.	
1	RSTA4745	<b>LED STRIP 3000 S 927/24V 5M</b>	20.0	2920	160		6.3	D	2	10
1	RSTA4755	<b>LED STRIP 3000 S 930/24V 5M</b>	20.0	3010	160		6.3	D	2	10
1	RSTA4765	<b>LED STRIP 3000 S 940/24V 5M</b>	20.0	3160	160		6.3	D	2	10
1	RSTA4775	<b>LED STRIP 3000 S 965/24V 5M*</b>	20.0	3130	160		6.3	D	2	10

**Note:** For appropriate operation of the LED Strip, an aluminum profile is required for cooling.

\* LED strips with color temperature 6500 K available on request, only.



## Available lengths

		mm	m	article no.	article no.	article no.
1	<b>LED STRIP 3000 S 927/24V</b>	50	5	RSTA4745	RSTA4740	RSTA4741
1	<b>LED STRIP 3000 S 930/24V</b>	50	5	RSTA4755	RSTA4750	RSTA4751
1	<b>LED STRIP 3000 S 940/24V</b>	50	5	RSTA4765	RSTA4760	RSTA4761
1	<b>LED STRIP 3000 S 965/24V*</b>	50	5	RSTA4775	RSTA4770	RSTA4771

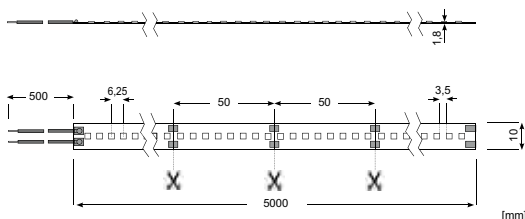



## Feed-in connector for LED Strips

**STRIP CON**  
2PIN 10MM/50CM  
FXZA4461



## Strip to strip connector

**STRIP CABLE BRIDGE**  
2PIN 10MM/5CM 4PCS  
FXZA4510



Please refer to [page 54](#) for further product information.

## Profiles

**PROFILE SMALL U FLAT**  
17.3/9.6/B1C1 1M  
TRPA2511

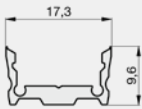

**PROFILE SMALL U**  
17.3/16/B1C1 1M  
TRPA2501

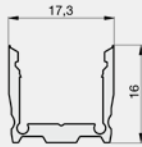

**PROFILE SMALL WING**  
25/13/B1C1 1M  
TRPA2521

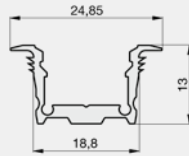

**PROFILE SMALL CORNER**  
22.8/22.8/B1C1 1M  
TRPA2531

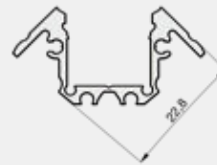

## Covers

**COVER SMALL F**  
16.4/4/C1 1M  
ZTPA2571

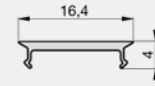

**COVER SMALL SQUARE**  
17/9/C1 1M  
ZTPA3111

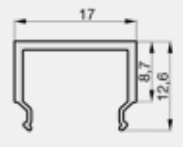

**PROFILE MEDIUM U FLAT**  
27/10.2/B2C2 1M  
TRPA2551

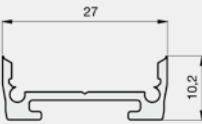

**PROFILE MEDIUM U**  
27/25.9/B2C2 1M  
TRPA2541

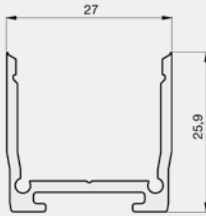

**PROFILE MEDIUM WING**  
40/25.9/B2C2 1M  
TRPA2561

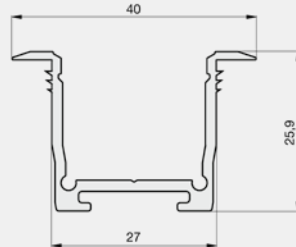

**COVER MEDIUM F**  
26/5/C2 1M  
ZTPA2591

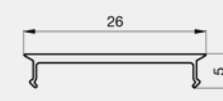

**COVER MEDIUM SQUARE**  
27/14/C2 1M  
ZTPA3121

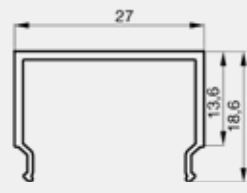

Please find further profiles, covers and accessories as well as product information on [page 58 ff.](#)

## Power Supply

**Not dimmable**  
**DRIVER FLAT 120W/24V IP20**  
**RADIUM**  
OTNA3105



**Dimmable Phasecut**  
**DRIVER PHASECUT 75W/24V**  
**IP20 RADIUM**  
OTDA3026



**Dimmable DALI**  
**DRIVER DALI 1CH 100W/24V**  
**IP20 RADIUM**  
OTDA4072



**Dimmable Casambi (Bluetooth)**  
**DRIVER BT 1CH 100W/24V**  
**IP20 TRIDONIC**  
OTDA2445



**LED Star Strip 3000**



6.0 m

**LED Star Strip 3000**



3.7 m

**LED Star Strip 3000**



5.0 m

**LED Star Strip 3000**



5.0 m

Please refer to [page 80 ff.](#) for further information on control gears, dimmers and accessories.

Please refer to [page 88 ff.](#) for further information on control units.

# LED Star Strip 1000 ZeroPitch and 400 ZeroPitch Furniture



## Product features:

- Very long lifespan: **60,000 h L70B10**
- Very good colour rendering: **CRI >90**
- Suitable for operation on **24 V DC**
- Wide beam angle: **160°**

## Advantages:

- Continuous light line without LED dots
- Perfectly suited for use in super-flat profiles or for furniture installation
- Low glare compared to SMD LEDs



## LED Star Strip 1000 ZeroPitch

		W	lm	LEDs	mm	pcs.	
1	RSTA2945	LED STRIP 1000ZP S 927/24V 5M	10.0	820	544	2	10
1	RSTA2955	LED STRIP 1000ZP S 930/24V 5M	10.0	900	544	2	10
1	RSTA2965	LED STRIP 1000ZP S 940/24V 5M	10.0	980	544	2	10
1	RSTA2975	LED STRIP 1000ZP S 965/24V 5M*	10.0	1000	544	2	10

## LED Star Strip 400 ZeroPitch Furniture

2	RSTA3783	LED STRIP 400ZPF S 927/24V 3M	4.5	320	420	2	10
2	RSTA3793	LED STRIP 400ZPF S 930/24V 3M	4.5	350	420	2	10
2	RSTA3803	LED STRIP 400ZPF S 940/24V 3M	4.5	400	420	2	10

\* LED strips with color temperature 6500 K available on request, only.



## Available lengths

	mm	m	article no.	article no.	article no.
1	LED STRIP 1000ZP S 927/24V	29.4	5	RSTA2945	RSTA2940 RSTA2941
1	LED STRIP 1000ZP S 930/24V	29.4	5	RSTA2955	RSTA2950 RSTA2951
1	LED STRIP 1000ZP S 940/24V	29.4	5	RSTA2965	RSTA2960 RSTA2961
1	LED STRIP 1000ZP S 965/24V*	29.4	5	RSTA2975	RSTA2970 RSTA2971
2	LED STRIP 400ZPF S 927/24V	16.7	3	RSTA3783	- -
2	LED STRIP 400ZPF S 930/24V	16.7	3	RSTA3793	- -
2	LED STRIP 400ZPF S 940/24V	16.7	3	RSTA3803	- -

\*\*Note: 3 meters for LED STRIP 400ZPF

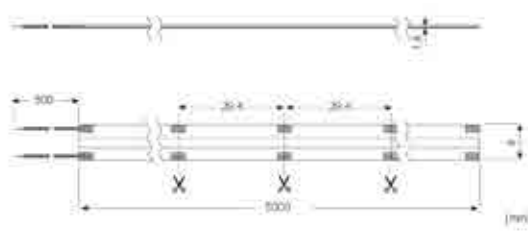

1

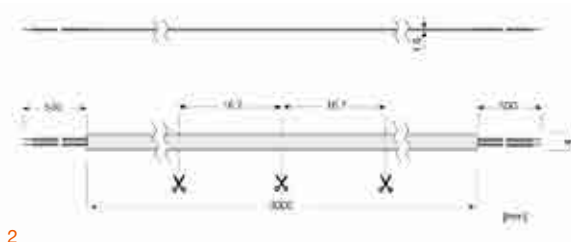

2

## Individual Cut

### SERVICE CUT STRIP

Our ZeroPitch LED strips are assembled exactly according to your specifications. The individual lengths are delivered with 0.5 m long soldered cable as standard.

For more information on customizing, please refer to [page 11](#).

## Feed-in connector for LED Strips

**STRIP CON 2PIN**  
**8MM/50CM\***  
**FXZA4460**



Please refer to [page 54](#) for further product information.

\*Note: Not compatible with LED Star Strip ZeroPitch Furniture.

## Profiles

**PROFILE SMALL U FLAT**  
**17.3/9.6/B1C1 1M**  
 TRPA2511

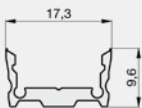

**PROFILE SMALL U**  
**17.3/16/B1C1 1M**  
 TRPA2501

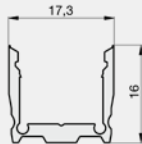

**PROFILE SMALL WING**  
**25/13/B1C1 1M**  
 TRPA2521

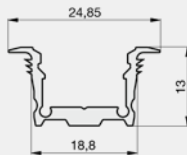

**PROFILE SMALL CORNER**  
**22.8/22.8/B1C1 1M**  
 TRPA2531

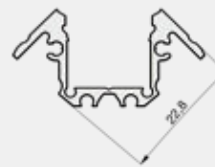

## Covers

**COVER SMALL F**  
**16.4/4/C1 1M**  
 ZTPA2571

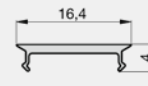

**COVER SMALL SQUARE**  
**17/9/C1 1M**  
 ZTPA3111

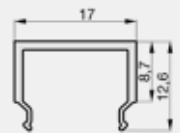

**PROFILE MEDIUM U FLAT**  
**27/10.2/B2C2 1M**  
 TRPA2551

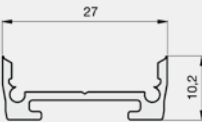

**PROFILE MEDIUM U**  
**27/25.9/B2C2 1M**  
 TRPA2541

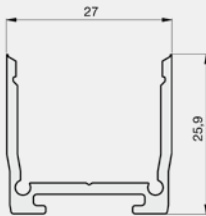

**PROFILE MEDIUM WING**  
**40/25.9/B2C2 1M**  
 TRPA2561

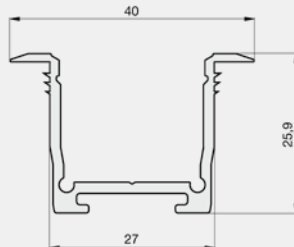

**COVER MEDIUM F**  
**26/5/C2 1M**  
 ZTPA2591

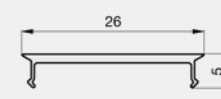

**COVER MEDIUM SQUARE**  
**27/14/C2 1M**  
 ZTPA3121

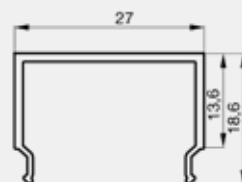

Please find further profiles, covers and accessories as well as product information on [page 58 ff.](#)

## Power Supply

**Not dimmable**  
**DRIVER FLAT 60W/24V**  
**IP20 RADIUM**  
 OTNA3103



**Dimmable Phasecut**  
**DRIVER PHASECUT 75W/24V**  
**IP20 RADIUM**  
 OTDA3026

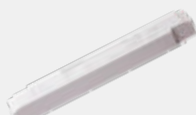

**Dimmable DALI**  
**DRIVER DALI 2CH 75W/24V**  
**IP20 RADIUM**  
 OTDA4074



**Dimmable Casambi (Bluetooth)**  
**DRIVER BT 1CH 60W/24V IP20**  
**TRIDONIC**  
 OTDA2444



**LED Star Strip**  
**1000 ZeroPitch** 6.0 m  
**400 ZeroPitch Furniture** 13.3 m



**LED Star Strip**  
**1000 ZeroPitch** 7.5 m  
**400 ZeroPitch Furniture** 16.6 m



**LED Star Strip**  
**1000 ZeroPitch** 7.5 m  
**400 ZeroPitch Furniture** 16.6 m



**LED Star Strip**  
**1000 ZeroPitch** 6.0 m  
**400 ZeroPitch Furniture** 13.3 m



Please refer to [page 80 ff.](#) for further information on control gears, dimmers and accessories.

Please refer to [page 88 ff.](#) for further information on control units.

# LED Star Strip 2000 and 3100 Tunable White



## Product features 2000 TW:

- Very long lifespan: **60,000 h L70B10**
- Very good colour rendering: **CRI >80**
- Suitable for operation on **24 V DC**
- Variable colour temperature: **Tunable White (2700-6500 K) and Tunable Warmwhite (2200-4000 K)**

## Product features 3100 TW:

- Very long lifespan: **60,000 h L80B50**
- Very good colour rendering: **CRI >90**
- Suitable for operation on **24 V DC**
- Variable colour temperature: **Tunable White (2700-6500 K)**

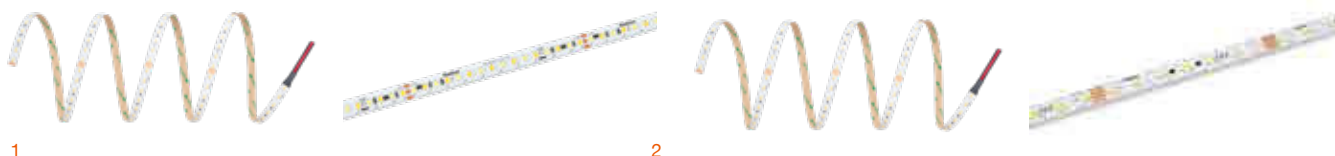

### LED Star Strip 2000 Tunable White

						mm		pcs.		
1	RSTA2205	<b>LED STRIP 2000 S TWW/24V 5M</b>	19.2	1950	140		14.3	F	3	10
1	RSTA2195	<b>LED STRIP 2000 S TW/24V 5M</b>	19.2	2020	140		14.3	F	3	10

### LED Star Strip 3100 Tunable White

2	RSTA4785	<b>LED STRIP 3100 S TW/24V 5M</b>	20.5	3100	160		12.5	D	3	10
---	----------	-----------------------------------	------	------	-----	--	------	---	---	----

**Note:** For appropriate operation of the LED Strip, an aluminum profile is required for cooling.

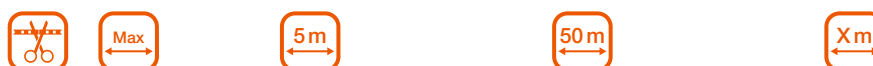

### Available lengths

		mm	m	article no.	article no.	article no.
1	<b>LED STRIP 2000 S TWW/24V</b>	100	7	RSTA2205	RSTA2200	RSTA2201
1	<b>LED STRIP 2000 S TW/24V</b>	100	7	RSTA2195	RSTA2190	RSTA2191
2	<b>LED STRIP 3100 S TW/24V</b>	100	5	RSTA4785	RSTA4780	RSTA4781

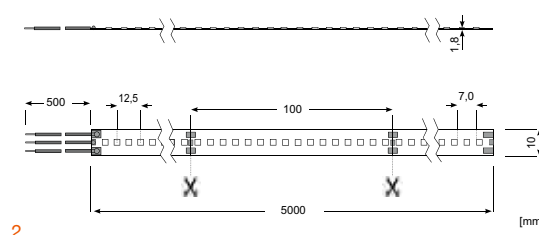
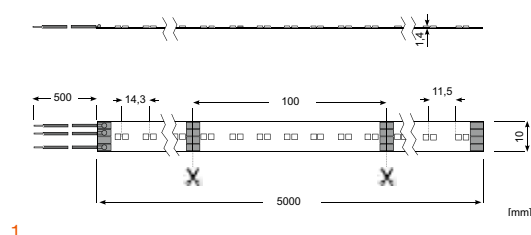



## Individual Cut

### SERVICE CUT STRIP

Our Tunable White LED Strip will be assembled centimetre-precise according to your specifications. The individual lengths are delivered with 0.5 m long soldered cable as standard.

For more information on customizing, please refer to [page 11](#).

### Profiles

**PROFILE SMALL U FLAT**  
17.3/9.6/B1C1 1M  
TRPA2511

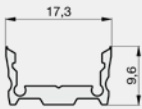

**PROFILE SMALL U**  
17.3/16/B1C1 1M  
TRPA2501

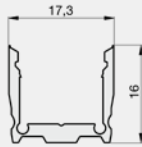

**PROFILE SMALL WING**  
25/13/B1C1 1M  
TRPA2521

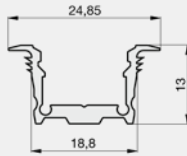

**PROFILE SMALL CORNER**  
22.8/22.8/B1C1 1M  
TRPA2531

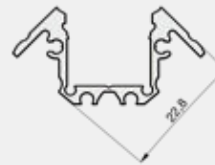

### Covers

**COVER SMALL F**  
16.4/4/C1 1M  
ZTPA2571

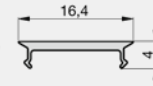

**COVER SMALL SQUARE**  
17/9/C1 1M  
ZTPA3111

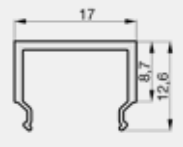

**PROFILE MEDIUM U FLAT**  
27/10.2/B2C2 1M  
TRPA2551

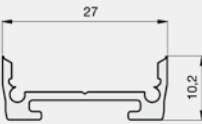

**PROFILE MEDIUM U**  
27/25.9/B2C2 1M  
TRPA2541

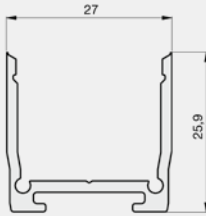

**PROFILE MEDIUM WING**  
40/25.9/B2C2 1M  
TRPA2561

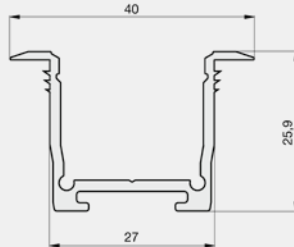

**COVER MEDIUM F**  
26/5/C2 1M  
ZTPA2591

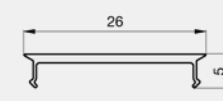

**COVER MEDIUM SQUARE**  
27/14/C2 1M  
ZTPA3121

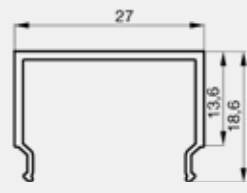

Please find further profiles, covers and accessories as well as product information on [page 58 ff.](#)

### Power Supply

**Dimmable DALI**  
DRIVER DALI 2CH 75W/24V  
IP20 RADIUM  
OTDA4074

**Dimmable DALI**  
DRIVER DALI 2CH 150W/24V  
IP20 RADIUM  
OTDA4075

### Control Units

**Light control Zigbee\***  
DIMMER ZIGBEE 5CH  
480W/12-24V IP20  
LMZA4000

**Light control Casambi (PWM4)\***  
CBU-PWM4-LR  
LMBA4969



<b>LED Star Strip 2000 TW</b>	3.9 m
<b>LED Star Strip 2000 TWW</b>	3.9 m
<b>LED Star Strip 3100 TW</b>	3.6 m



<b>LED Star Strip 2000 TW</b>	7.8 m
<b>LED Star Strip 2000 TWW</b>	7.8 m
<b>LED Star Strip 3100 TW</b>	7.3 m



<b>LED Star Strip 2000 TW</b>	25.0 m
<b>LED Star Strip 2000 TWW</b>	25.0 m
<b>LED Star Strip 3100 TW</b>	23.4 m



<b>LED Star Strip 2000 TW</b>	7.5 m
<b>LED Star Strip 2000 TWW</b>	7.5 m
<b>LED Star Strip 3100 TW</b>	7.0 m

Please refer to [page 80 ff.](#) for further information on control gears, dimmers and accessories.

Please refer to [page 88 ff.](#) for further information on control units.

\*Note: A 24V DC LED driver is required for operation.

# LED Star Strip 900 and 1500 WarmDIM



## Product features:

- Very long lifespan: **60,000 h L70B10**
- Very good colour rendering: **CRI >90**
- Suitable for operation on **24 V DC**
- High colour consistency: **SDCM <3**

## Advantages:

- Automatic adaption of lighting mood while dimming down
- Warm white light at 100% and super warm white light, when dimmed (4000–1900 K / 3000–1900 K)
- No need for two-channel DALI dimmer or any other control unit
- Optimized dimming curve for an accurate transition



1



## LED Star Strip 900 and 1500 WarmDIM

							mm		pcs.	
1	RSTA2905	<b>LED STRIP 900WD S 930-919/24V 5M</b>	10.0	890	168		11.9	G	2	10
1	RSTA2915	<b>LED STRIP 900WD S 940-919/24V 5M</b>	10.0	950	168		11.9	F	2	10
1	RSTA2925	<b>LED STRIP 1500WD S 930-919/24V 5M</b>	14.4	1410	168		11.9	F	2	10
1	RSTA2935	<b>LED STRIP 1500WD S 940-919/24V 5M</b>	14.4	1500	168		11.9	F	2	10



## Available lengths

		mm	m	article no.	article no.	article no.
1	<b>LED STRIP 900WD S 930-919/24V</b>	83.3	5	RSTA2905	RSTA2900	RSTA2901
1	<b>LED STRIP 900WD S 940-919/24V</b>	83.3	5	RSTA2915	RSTA2910	RSTA2911
1	<b>LED STRIP 1500WD S 930-919/24V</b>	83.3	5	RSTA2925	RSTA2920	RSTA2921
1	<b>LED STRIP 1500WD S 940-919/24V</b>	83.3	5	RSTA2935	RSTA2930	RSTA2931

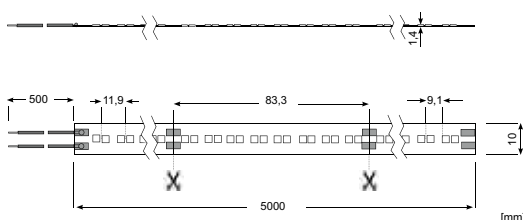

1

## Feed-in connector for LED Strips

**STRIP CON 2PIN**  
**10MM/50CM**  
 FXZA4461



Please refer to [page 54](#) for further product information.

## Profiles

**PROFILE SMALL U FLAT**  
**17.3/9.6/B1C1 1M**  
 TRPA2511

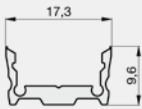

**PROFILE SMALL U**  
**17.3/16/B1C1 1M**  
 TRPA2501

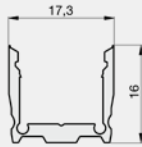

**PROFILE SMALL WING**  
**25/13/B1C1 1M**  
 TRPA2521

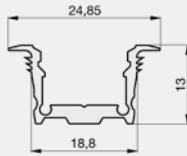

**PROFILE SMALL CORNER**  
**22.8/22.8/B1C1 1M**  
 TRPA2531

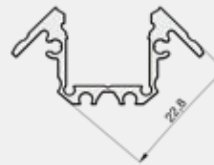

## Covers

**COVER SMALL F**  
**16.4/4/C1 1M**  
 ZTPA2571

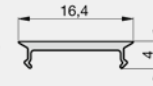

**COVER SMALL SQUARE**  
**17/9/C1 1M**  
 ZTPA3111

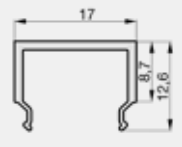

**PROFILE MEDIUM U FLAT**  
**27/10.2/B2C2 1M**  
 TRPA2551

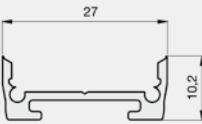

**PROFILE MEDIUM U**  
**27/25.9/B2C2 1M**  
 TRPA2541

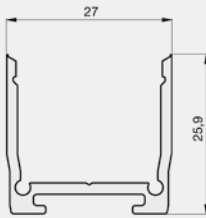

**PROFILE MEDIUM WING**  
**40/25.9/B2C2 1M**  
 TRPA2561

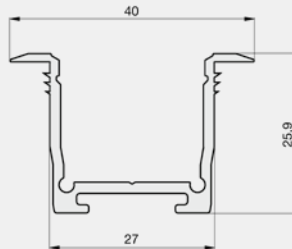

**COVER MEDIUM F**  
**26/5/C2 1M**  
 ZTPA2591

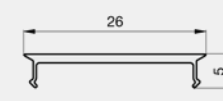

**COVER MEDIUM SQUARE**  
**27/14/C2 1M**  
 ZTPA3121

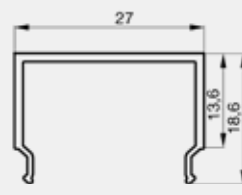

Please find further profiles, covers and accessories as well as product information on [page 58 ff.](#)

## Power Supply

**Dimmable Phasecut**  
**DRIVER PHASECUT 75W/24V**  
**IP20 RADIUM**  
 OTDA3026



**Dimmable DALI**  
**DRIVER DALI 1CH 100W/24V**  
**IP20**  
 OTDA4072



**Dimmable Casambi (Bluetooth)**  
**DRIVER BT 1CH 100W/24V**  
**IP20 TRIDONIC**  
 OTDA2445



## Control Unit

**Light control Casambi (PWM4)\***  
**CBU-PWM4-LR**  
 LMBA4969



**LED Star Strip**  
**900 WarmDIM** 7.5 m  
**1500 WarmDIM** 5.2 m



**LED Star Strip**  
**900 WarmDIM** 10.0 m  
**1500 WarmDIM** 6.9 m



**LED Star Strip**  
**900 WarmDIM** 10.0 m  
**1500 WarmDIM** 6.9 m



**LED Star Strip**  
**900 WarmDIM** 14.4 m  
**1500 WarmDIM** 10.0 m



Please refer to [page 80 ff.](#) for further information on control gears, dimmers and accessories.

Please refer to [page 88 ff.](#) for further information on control units.

\*Note: A 24V DC LED driver is required for operation.

# LED Star Strip 500 RGB and 700 RGBW



## Product features:

- Long lifespan: **30,000 h L70B10**
- Dynamic coloured light due to RGB LEDs
- Suitable for operation on **24 V DC**
- Optimal function with multi-channel LED dimmers



## LED Star Strip 500 RGB

					mm	pcs.
1	RSTA2175	<b>LED STRIP 500 S RGB/24V 5M*</b>	14.4	560	70	14.3 4 10

## LED Star Strip 700 RGBW

2	RSTA2185	<b>LED STRIP 700 S RGBW/24V 5M</b>	12.0	700	70	14.3 5 10
---	----------	------------------------------------	------	-----	----	-----------

\*Note: For appropriate operation of the LED Strip, an aluminum profile is required for cooling.



## Available lengths

		mm	m	article no.	article no.	article no.
1	<b>LED STRIP 500 S RGB/24V</b>	100	7	RSTA2175	RSTA2170	RSTA2171
2	<b>LED STRIP 700 S RGBW/24V</b>	100	8	RSTA2185	RSTA2180	RSTA2181

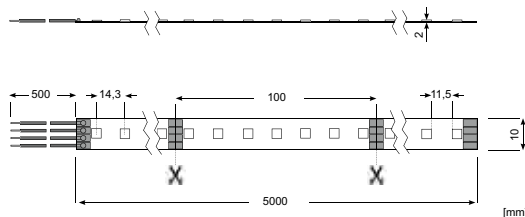

1

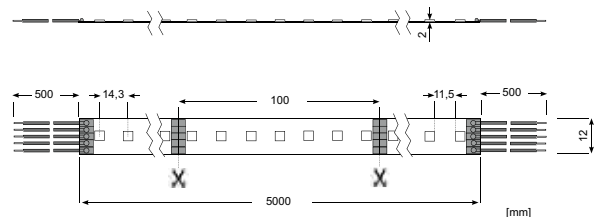

2



## Feed-in connector for LED Strips

**STRIP CON CP**  
4PIN 10MM/50CM\*  
FXZA2471



## Strip to strip connector

**STRIP CABLE BRIDGE CP**  
4PIN 10MM/5CM\*  
FXZA2478



**STRIP BRIDGE CP**  
4PIN 10MM\*  
FXZA2476



Please refer to [page 54](#) for further product information.

\*Note: Not compatible with LED Star Strip 700 RGBW. Accessory compatibility on [page 56-57](#).

## Profiles

**PROFILE SMALL U FLAT**  
17.3/9.6/B1C1 1M  
TRPA2511

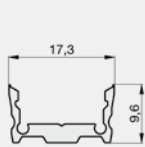

**PROFILE SMALL U**  
17.3/16/B1C1 1M  
TRPA2501

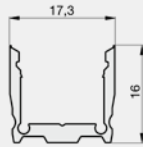

**PROFILE SMALL WING**  
25/13/B1C1 1M  
TRPA2521

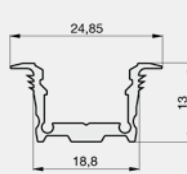

**PROFILE SMALL CORNER**  
22.8/22.8/B1C1 1M  
TRPA2531

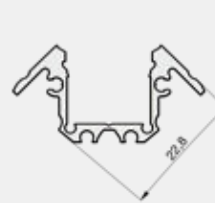

## Covers

**COVER SMALL F**  
16.4/4/C1 1M  
ZTPA2571

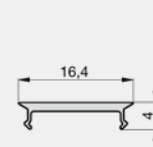

**COVER SMALL SQUARE**  
17/9/C1 1M  
ZTPA3111

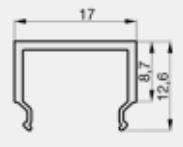

**PROFILE MEDIUM U FLAT**  
27/10.2/B2C2 1M  
TRPA2551

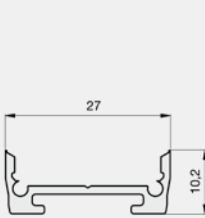

**PROFILE MEDIUM U**  
27/25.9/B2C2 1M  
TRPA2541

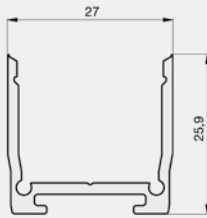

**PROFILE MEDIUM WING**  
40/25.9/B2C2 1M  
TRPA2561

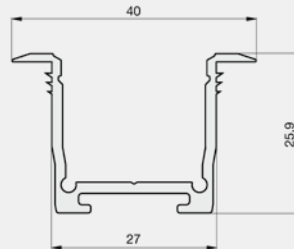

**COVER MEDIUM F**  
26/5/C2 1M  
ZTPA2591

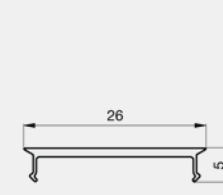

**COVER MEDIUM SQUARE**  
27/14/C2 1M  
ZTPA3121

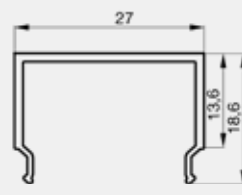

Please find further profiles, covers and accessories as well as product information on [page 58 ff.](#)

## Power Supply

**Dimmable DALI/DMX**  
**DRIVER DALI/DMX 4CH 150W/24V**  
**IP20 RADIUM**  
OTDA4076



LED Star Strip	
500 RGB	10.4 m
700 RGBW	12.5 m

## Control Units

**Light control Zigbee\***  
**DIMMER ZIGBEE 5CH**  
**480W/12-24V IP20**  
LMZA4000



LED Star Strip	
500 RGB	19.0 m
700 RGBW	24.0 m

**Light control Casambi (PWM4)\***  
**CBU-PWM4-LR**  
LMBA4969



LED Star Strip	
500 RGB	10.0 m
700 RGBW	12.0 m

Please refer to [page 80 ff.](#) for further information on control gears, dimmers and accessories.

Please refer to [page 88 ff.](#) for further information on control units.

\*Note: A 24V DC LED driver is required for operation.

# LED Star Strip 400 and 800 Waterproof



## Product features:

- Very long lifespan: **60,000 h L80B50**
- Very good colour rendering: **CRI >90**
- Suitable for operation on **24 V DC**
- High degree of protection thanks to high-quality silicone encapsulation: **IP67**
- Very high efficiency of up to **147 lm/W**

## Advantages:

- Long max. operable length without loss of luminous flux thanks to IC and high copper content in PCB
- Homogeneous light with **160 LEDs per meter**
- Protection against UV radiation, chlorine and common cleaning agents



## LED Star Strip 400 Waterproof

							mm		pcs.	
1	RSTA4795	<b>LED STRIP 400 S 927/24V/IP67 5M</b>	2.8	375	80	●	12.5	E	2	10
1	RSTA4805	<b>LED STRIP 400 S 930/24V/IP67 5M</b>	2.8	390	80	●	12.5	E	2	10
1	RSTA4815	<b>LED STRIP 400 S 940/24V/IP67 5M</b>	2.8	405	80	○	12.5	E	2	10
1	RSTA4825	<b>LED STRIP 400 S 965/24V/IP67 5M*</b>	2.8	400	80	●	12.5	E	2	10

## LED Star Strip 800 Waterproof

2	RSTA4835	<b>LED STRIP 800 S 927/24V/IP67 5M</b>	5.6	755	160	●	6.3	E	2	10
2	RSTA4845	<b>LED STRIP 800 S 930/24V/IP67 5M</b>	5.6	780	160	●	6.3	E	2	10
2	RSTA4855	<b>LED STRIP 800 S 940/24V/IP67 5M</b>	5.6	825	160	○	6.3	D	2	10
2	RSTA4865	<b>LED STRIP 800 S 965/24V/IP67 5M*</b>	5.6	815	160	●	6.3	E	2	10

\* LED strips with color temperature 6500 K available on request, only.



## Available lengths

		mm	m	article no.	article no.	article no.
1	<b>LED STRIP 400 S 927/24V/IP67</b>	100	18	RSTA4795	RSTA4790	RSTA4791
1	<b>LED STRIP 400 S 930/24V/IP67</b>	100	18	RSTA4805	RSTA4800	RSTA4801
1	<b>LED STRIP 400 S 940/24V/IP67</b>	100	18	RSTA4815	RSTA4810	RSTA4811
1	<b>LED STRIP 400 S 965/24V/IP67*</b>	100	18	RSTA4825	RSTA4820	RSTA4821
2	<b>LED STRIP 800 S 927/24V/IP67</b>	50	13	RSTA4835	RSTA4830	RSTA4831
2	<b>LED STRIP 800 S 930/24V/IP67</b>	50	13	RSTA4845	RSTA4840	RSTA4841
2	<b>LED STRIP 800 S 940/24V/IP67</b>	50	13	RSTA4855	RSTA4850	RSTA4851
2	<b>LED STRIP 800 S 965/24V/IP67*</b>	50	13	RSTA4865	RSTA4860	RSTA4861

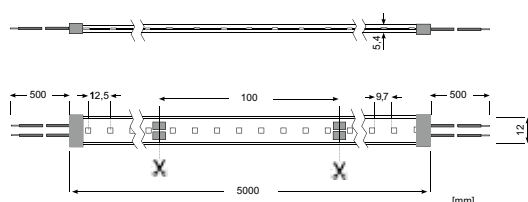

1

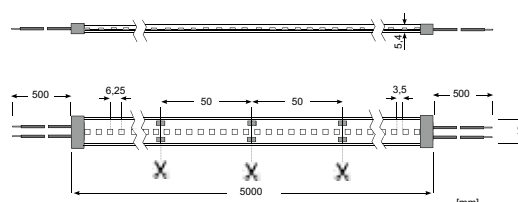

2

## Individual Cut

### SERVICE CUT STRIP

We would be happy to assemble our waterproof LED-Strips according to your specifications. The individual lengths are supplied with an IP67 cable on every one of both ends.

## Accessories for waterproof strips

(A corresponding number of end caps and accessories are included with the waterproof LED Strips)

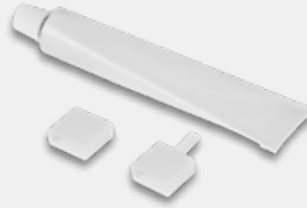

For more information on customizing, please refer to [page 11](#).

Please refer to [page 54](#) for further product information.

## Profiles

**PROFILE SMALL U FLAT**  
17.3/9.6/B1C1 1M\*  
TRPA2511

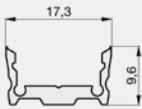

**PROFILE SMALL U**  
17.3/16/B1C1 1M  
TRPA2501

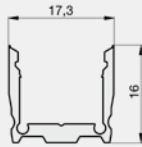

**PROFILE SMALL WING**  
25/13/B1C1 1M  
TRPA2521

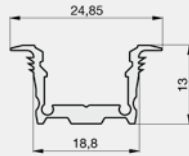

**PROFILE SMALL CORNER**  
22.8/22.8/B1C1 1M  
TRPA2531

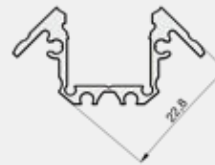

## Covers

**COVER SMALL F**  
16.4/4/C1 1M  
ZTPA2571

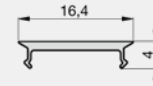

**COVER SMALL SQUARE**  
17/9/C1 1M  
ZTPA3111

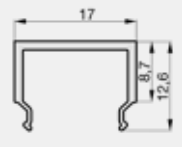

**PROFILE MEDIUM U FLAT**  
27/10.2/B2C2 1M\*  
TRPA2551

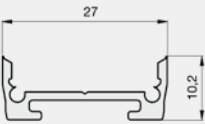

**PROFILE MEDIUM U**  
27/25.9/B2C2 1M  
TRPA2541

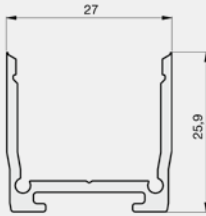

**PROFILE MEDIUM WING**  
40/25.9/B2C2 1M  
TRPA2561

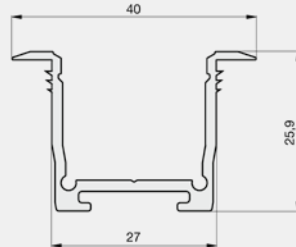

**COVER MEDIUM F**  
26/5/C2 1M  
ZTPA2591

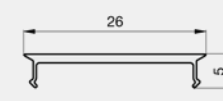

**COVER MEDIUM SQUARE**  
27/14/C2 1M  
ZTPA3121

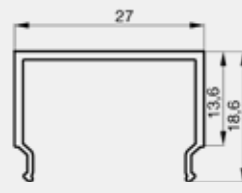

Please find further profiles, covers and accessories as well as product information on [page 58 ff.](#)

\*Only compatible with waterproof LED Strips without cover.

## Power Supply

**Not dimmable**  
**DRIVER 75W/24V IP67**  
MeanWell  
OTNA2450



**LED Star Strip 400 IP67** 26.7 m  
**LED Star Strip 800 IP67** 13.3 m

**Dimmable 1-10V**  
**DRIVER 1-10V 20W/24V**  
IP66 OSRAM  
OTDA2424



**LED Star Strip 400 IP67** 7.1 m  
**LED Star Strip 800 IP67** 3.5 m

**Dimmable DALI**  
**DRIVER DALI 4CH 100W/24V**  
IP67  
OTDA4107



**LED Star Strip 400 IP67** 35.7 m  
**LED Star Strip 800 IP67** 17.8 m

**Dimmable Casambi (Bluetooth)**  
**DRIVER BT 1CH 35W/24V**  
IP20  
OTDA2443



**LED Star Strip 400 IP67** 12.5 m  
**LED Star Strip 800 IP67** 6.2 m

Please refer to [page 80 ff.](#) for further information on control gears, dimmers and accessories.

Please refer to [page 88 ff.](#) for further information on control units.

# LED Star Strip 1300 and 2000 Waterproof



## Product features:

- Very long lifespan: **60,000 h L80B50**
- Very good colour rendering: **CRI >90**
- Suitable for operation on **24 V DC**
- High degree of protection thanks to high-quality silicone encapsulation: **IP67**
- Very high efficiency of up to **149 lm/W**

## Advantages:

- Long max. operable length without loss of luminous flux thanks to IC and high copper content in PCB
- Homogeneous light with **160 LEDs per meter**
- Protection against UV radiation, chlorine and common cleaning agents



1



## LED Star Strip 1300 Waterproof

						mm			pcs.
1	RSTA4875	<b>LED STRIP 1300 S 927/24V/IP67 5M</b>	9.0	1240	160	6.3	E	2	10
1	RSTA4885	<b>LED STRIP 1300 S 930/24V/IP67 5M</b>	9.0	1280	160	6.3	E	2	10
1	RSTA4895	<b>LED STRIP 1300 S 940/24V/IP67 5M</b>	9.0	1340	160	6.3	D	2	10
1	RSTA4905	<b>LED STRIP 1300 S 965/24V/IP67 5M*</b>	9.0	1330	160	6.3	D	2	10

## LED Star Strip 2000 Waterproof

1	RSTA4915	<b>LED STRIP 2000 S 927/24V/IP67 5M</b>	14.0	1890	160	6.3	E	2	10
1	RSTA4925	<b>LED STRIP 2000 S 930/24V/IP67 5M</b>	14.0	1935	160	6.3	E	2	10
1	RSTA4935	<b>LED STRIP 2000 S 940/24V/IP67 5M</b>	14.0	2025	160	6.3	E	2	10
1	RSTA4945	<b>LED STRIP 2000 S 965/24V/IP67 5M*</b>	14.0	2010	160	6.3	E	2	10

Note: For appropriate operation of the LED Strip, an aluminum profile is required for cooling.

\* LED strips with color temperature 6500 K available on request, only.



## Available lengths

		mm	m	article no.	article no.	article no.
1	<b>LED STRIP 1300 S 927/24V/IP67</b>	50	10	RSTA4875	RSTA4870	RSTA4871
1	<b>LED STRIP 1300 S 930/24V/IP67</b>	50	10	RSTA4885	RSTA4880	RSTA4881
1	<b>LED STRIP 1300 S 940/24V/IP67</b>	50	10	RSTA4895	RSTA4890	RSTA4891
1	<b>LED STRIP 1300 S 965/24V/IP67*</b>	50	10	RSTA4905	RSTA4900	RSTA4901
1	<b>LED STRIP 2000 S 927/24V/IP67</b>	50	7	RSTA4915	RSTA4910	RSTA4911
1	<b>LED STRIP 2000 S 930/24V/IP67</b>	50	7	RSTA4925	RSTA4920	RSTA4921
1	<b>LED STRIP 2000 S 940/24V/IP67</b>	50	7	RSTA4935	RSTA4930	RSTA4931
1	<b>LED STRIP 2000 S 965/24V/IP67*</b>	50	7	RSTA4945	RSTA4940	RSTA4941

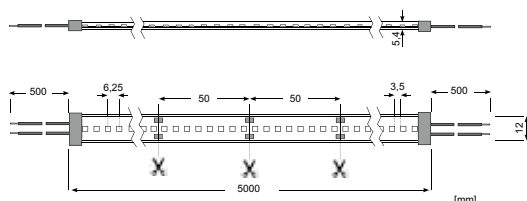

1



## Individual Cut

### SERVICE CUT STRIP

We would be happy to assemble our waterproof LED-Strips according to your specifications. The individual lengths are supplied with an IP67 cable on every one of both ends.

## Accessories for waterproof strips

(A corresponding number of end caps and accessories are included with the waterproof LED Strips)

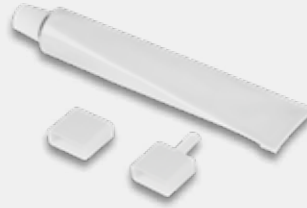

For more information on customizing, please refer to [page 11](#).

Please refer to [page 54](#) for further product information.

## Profiles

**PROFILE SMALL U FLAT**  
17.3/9.6/B1C1 1M\*  
TRPA2511

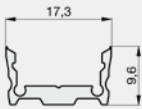

**PROFILE SMALL U**  
17.3/16/B1C1 1M  
TRPA2501

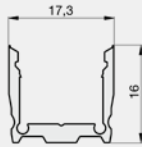

**PROFILE SMALL WING**  
25/13/B1C1 1M  
TRPA2521

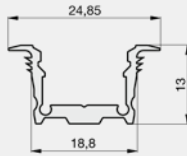

**PROFILE SMALL CORNER**  
22.8/22.8/B1C1 1M  
TRPA2531

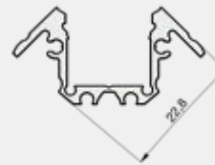

## Covers

**COVER SMALL F**  
16.4/4/C1 1M  
ZTPA2571

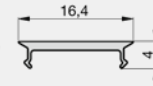

**COVER SMALL SQUARE**  
17/9/C1 1M  
ZTPA3111

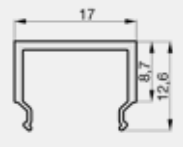

**PROFILE MEDIUM U FLAT**  
27/10.2/B2C2 1M\*  
TRPA2551

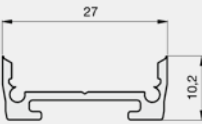

**PROFILE MEDIUM U**  
27/25.9/B2C2 1M  
TRPA2541

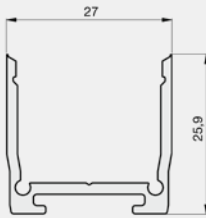

**PROFILE MEDIUM WING**  
40/25.9/B2C2 1M  
TRPA2561

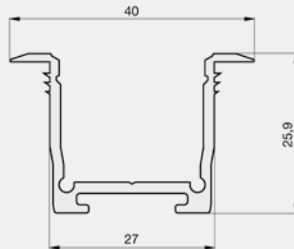

**COVER MEDIUM F**  
26/5/C2 1M  
ZTPA2591

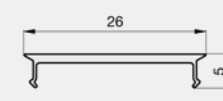

**COVER MEDIUM SQUARE**  
27/14/C2 1M  
ZTPA3121

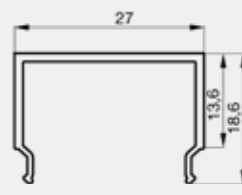

Please find further profiles, covers and accessories as well as product information on [page 58 ff.](#)

\*Only compatible with waterproof LED Strips without cover.

## Power Supply

**Not dimmable**  
**DRIVER 75W/24V**  
IP67 MeanWell  
OTNA2450



**Dimmable 1-10V**  
**DRIVER 1-10V 60W/24V**  
IP66 OSRAM  
OTDA2426



**Dimmable DALI**  
**DRIVER DALI 4CH 100W/24V**  
IP67  
OTDA4107



## Control Unit

**Light control Casambi (PWM4)\***  
**CBU-PWM4-LR**  
LMBA4969



**LED Star Strip 1500 IP67** 8.3 m  
**LED Star Strip 1900 IP67** 5.3 m



**LED Star Strip 1500 IP67** 6.6 m  
**LED Star Strip 1900 IP67** 4.2 m



**LED Star Strip 1500 IP67** 11.1 m  
**LED Star Strip 1900 IP67** 7.1 m



**LED Star Strip 1500 IP67** 16.0 m  
**LED Star Strip 1900 IP67** 10.2 m



Please refer to [page 80 ff.](#) for further information on control gears, dimmers and accessories.

Please refer to [page 88 ff.](#) for further information on control units.

\*Note: A 24V DC LED driver is required for operation.

# LED Star Strip 500 RGB Waterproof



## Product features:

- Long lifespan: **30,000 h L70B10**
- Coloured light due to RGB LEDs
- Suitable for operation on **24 V DC**

## Advantages:

- Long max. operable length without loss of luminous flux thanks to IC and high copper content in PCB
- High degree of protection thanks to high-quality silicone encapsulation: **IP67**
- Extra strong hold thanks to 3M adhesive tape



1



## LED Star Strip 500 RGB Waterproof

mm

pcs.

1	RSTA2415	<b>LED STRIP 500 S RGB/24V/IP67 5M</b>	14.4	500	70		14.3	4	10

**Note:** For appropriate operation of the LED Strip, an aluminum profile is required for cooling.



## Available lengths

mm

m

article no.

article no.

article no.

1	<b>LED STRIP 500 S RGB/24V/IP67</b>	100	7	RSTA2415	RSTA2410	RSTA2411
---	-------------------------------------	-----	---	----------	----------	----------

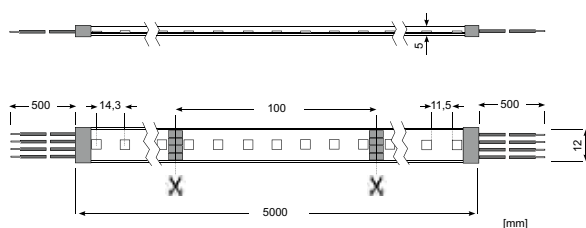

1

## Individual Cut

### SERVICE CUT STRIP

We would be happy to assemble our waterproof LED-Strips according to your specifications. The individual lengths are supplied with an IP67 cable on every one of both ends.

## Accessories for waterproof strips

(A corresponding number of end caps and accessories are included with the waterproof LED Strips)

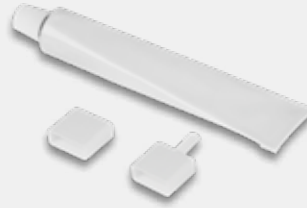

For more information on customizing, please refer to [page 11](#).

Please refer to [page 54](#) for further product information.

## Profiles

**PROFILE SMALL U FLAT**  
17.3/9.6/B1C1 1M\*  
TRPA2511

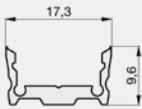

**PROFILE SMALL U**  
17.3/16/B1C1 1M  
TRPA2501

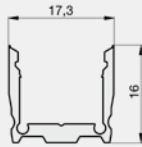

**PROFILE SMALL WING**  
25/13/B1C1 1M  
TRPA2521

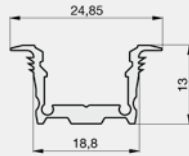

**PROFILE SMALL CORNER**  
22.8/22.8/B1C1 1M  
TRPA2531

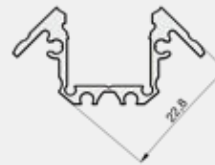

## Covers

**COVER SMALL F**  
16.4/4/C1 1M  
ZTPA2571

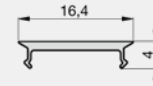

**COVER SMALL SQUARE**  
17/9/C1 1M  
ZTPA3111

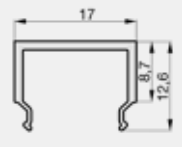

**PROFILE MEDIUM U FLAT**  
27/10.2/B2C2 1M\*  
TRPA2551

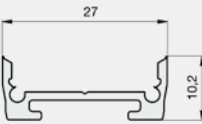

**PROFILE MEDIUM U**  
27/25.9/B2C2 1M  
TRPA2541

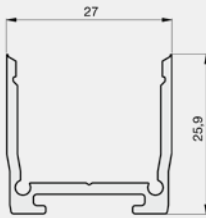

**PROFILE MEDIUM WING**  
40/25.9/B2C2 1M  
TRPA2561

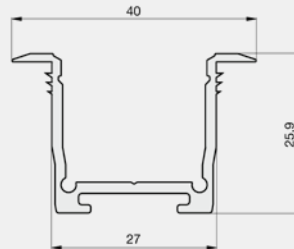

**COVER MEDIUM F**  
26/5/C2 1M  
ZTPA2591

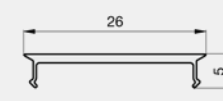

**COVER MEDIUM SQUARE**  
27/14/C2 1M  
ZTPA3121

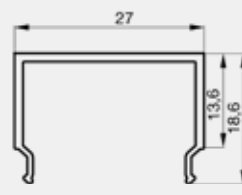

Please find further profiles, covers and accessories as well as product information on [page 58 ff.](#)

\*Only compatible with waterproof LED Strips without cover.

## Power Supply

**Dimmable DALI**  
**DRIVER DALI 4CH 210W/24V**  
**IP67 OSRAM**  
OTDA2461



**LED Star Strip**  
**500 RGB IP67** 14.5 m



**Dimmable DALI/DMX**  
**DRIVER DALI/DMX 4CH 150W/24V**  
**IP20 RADIUM**  
OTDA4076



**LED Star Strip**  
**500 RGB IP67** 10.4 m



## Control Unit

**Light control Casambi (PWM4)\***  
**CBU-PWM4-LR**  
LMBA4969



**LED Star Strip**  
**500 RGB IP67** 10.0 m



Please refer to [page 80 ff.](#) for further information on control gears, dimmers and accessories.

Please refer to [page 88 ff.](#) for further information on control units.

\*Note: A 24V DC LED driver is required for operation.

# LED Essence Strip 500 and 1000



## Product features:

- Very long lifespan: **50,000 h L70B50**
- Very good colour rendering: **CRI >90**
- Suitable for operation on **24 V DC**
- High colour consistency: **SDCM <3**
- Very high efficiency of up to **135 lm/W**



1



## LED Essence Strip 500

						mm				pcs.	
1	RSTA3515	LED STRIP 500 E 927/24V 5M	3.6	446	80	●	12.5	E	2	10	
1	RSTA3525	LED STRIP 500 E 930/24V 5M	3.6	454	80	●	12.5	E	2	10	
1	RSTA3535	LED STRIP 500 E 940/24V 5M	3.6	485	80	○	12.5	E	2	10	
1	RSTA3545	LED STRIP 500 E 965/24V 5M	3.6	475	80	●	12.5	E	2	10	

## LED Essence Strip 1000

1	RSTA3555	LED STRIP 1000 E 927/24V 5M	8.0	960	80	●	12.5	E	2	10	
1	RSTA3565	LED STRIP 1000 E 930/24V 5M	8.0	976	80	●	12.5	E	2	10	
1	RSTA3575	LED STRIP 1000 E 940/24V 5M	8.0	1040	80	○	12.5	E	2	10	
1	RSTA3585	LED STRIP 1000 E 965/24V 5M	8.0	1048	80	●	12.5	E	2	10	



## Available lengths

				article no.	
1	LED STRIP 500 E 927/24V 5M	100	7.0	RSTA3515	
1	LED STRIP 500 E 930/24V 5M	100	7.0	RSTA3525	
1	LED STRIP 500 E 940/24V 5M	100	7.0	RSTA3535	
1	LED STRIP 500 E 965/24V 5M	100	7.0	RSTA3545	
1	LED STRIP 1000 E 927/24V 5M	100	5.5	RSTA3555	
1	LED STRIP 1000 E 930/24V 5M	100	5.5	RSTA3565	
1	LED STRIP 1000 E 940/24V 5M	100	5.5	RSTA3575	
1	LED STRIP 1000 E 965/24V 5M	100	5.5	RSTA3585	

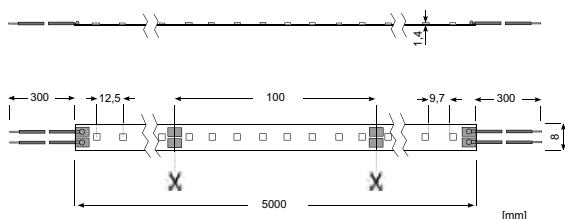

1

## Feed-in connector for LED Strips

**STRIP CON**  
2PIN 8MM/50CM  
FXZA4460

**STRIP CON SD**  
2PIN 8MM/SW  
FXZA2479



## Strip to strip connector

**STRIP CABLE BRIDGE CP**  
2PIN 8MM/5CM  
FXZA2477

**STRIP BRIDGE CP**  
2PIN 8MM  
FXZA2475



Please refer to [page 54](#) for further product information.

## Profiles

**PROFILE SMALL U FLAT**  
17.3/9.6/B1C1 1M  
TRPA2511

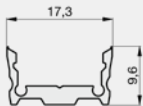

**PROFILE SMALL U**  
17.3/16/B1C1 1M  
TRPA2501

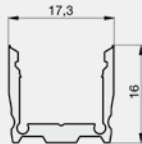

**PROFILE SMALL WING**  
25/13/B1C1 1M  
TRPA2521

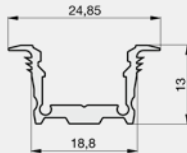

**PROFILE SMALL CORNER**  
22.8/22.8/B1C1 1M  
TRPA2531

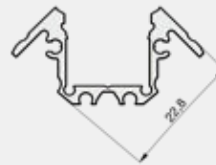

## Covers

**COVER SMALL F**  
16.4/4/C1 1M  
ZTPA2571

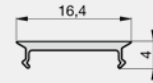

**COVER SMALL SQUARE**  
17/9/C1 1M  
ZTPA3111

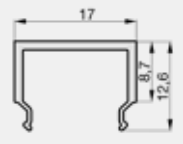

**PROFILE MEDIUM U FLAT**  
27/10.2/B2C2 1M  
TRPA2551

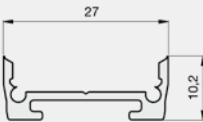

**PROFILE MEDIUM U**  
27/25.9/B2C2 1M  
TRPA2541

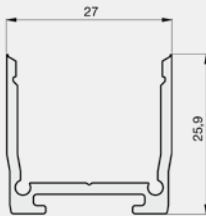

**PROFILE MEDIUM WING**  
40/25.9/B2C2 1M  
TRPA2561

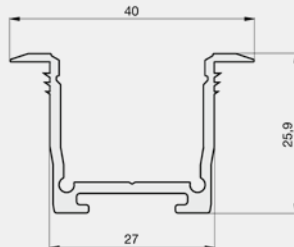

**COVER MEDIUM F**  
26/5/C2 1M  
ZTPA2591

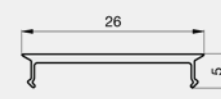

**COVER MEDIUM SQUARE**  
27/14/C2 1M  
ZTPA3121

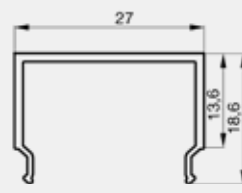

Please find further profiles, covers and accessories as well as product information on [page 58 ff.](#)

## Power Supply

**Not dimmable**  
**DRIVER FLAT 36W/24V**  
IP20 RADIUM  
OTNA3102



**Dimmable Phasecut**  
**DRIVER PHASECUT 36W/24V**  
IP20 RADIUM  
OTDA4077



**Dimmable DALI**  
**DRIVER DALI 1CH 36W/24V**  
IP20 RADIUM  
OTDA4070



**Dimmable Casambi (Bluetooth)**  
**DRIVER BT 1CH 60W/24V**  
IP20 TRIDONIC  
OTDA2444



**LED Essence Strip 500** 10.0 m  
**LED Essence Strip 1000** 4.5 m



**LED Essence Strip 500** 10.0 m  
**LED Essence Strip 1000** 4.5 m



**LED Essence Strip 500** 10.0 m  
**LED Essence Strip 1000** 4.5 m



**LED Essence Strip 500** 16.6 m  
**LED Essence Strip 1000** 7.5 m



Please refer to [page 80 ff.](#) for further information on control gears, dimmers and accessories.

Please refer to [page 88 ff.](#) for further information on control units.

# LED Essence Strip 1500



## Product features:

- Very long lifespan: **50,000 h L70B50**
- Very good colour rendering: **CRI >90**
- Suitable for operation on **24 V DC**
- High colour consistency: **SDCM <3**
- Very high efficiency of up to **128 lm/W**



1



## LED Essence Strip 1500

		mm						pcs.		
1	RSTA3595	<b>LED STRIP 1500 E 927/24V 5M</b>	12.0	1440	80		12.5	E	2	10
1	RSTA3605	<b>LED STRIP 1500 E 930/24V 5M</b>	12.0	1452	80		12.5	E	2	10
1	RSTA3615	<b>LED STRIP 1500 E 940/24V 5M</b>	12.0	1536	80		12.5	E	2	10
1	RSTA3625	<b>LED STRIP 1500 E 965/24V 5M</b>	12.0	1524	80		12.5	E	2	10



## Available lengths

		mm	m	article no.
1	<b>LED STRIP 1500 E 927/24V 5M</b>	100	5	RSTA3595
1	<b>LED STRIP 1500 E 930/24V 5M</b>	100	5	RSTA3605
1	<b>LED STRIP 1500 E 940/24V 5M</b>	100	5	RSTA3615
1	<b>LED STRIP 1500 E 965/24V 5M</b>	100	5	RSTA3625

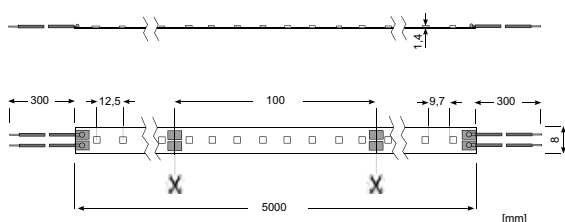

1



## Feed-in connector for LED Strips

**STRIP CON CP**  
2PIN 8MM/50CM  
FXZA2470

**STRIP CON SD**  
2PIN 8MM/SW  
FXZA2479

## Strip to strip connector

**STRIP CABLE BRIDGE CP**  
2PIN 8MM/5CM  
FXZA2477

**STRIP BRIDGE CP**  
2PIN 8MM  
FXZA2475



Please refer to [page 54](#) for further product information.

## Profiles

**PROFILE SMALL U FLAT**  
17.3/9.6/B1C1 1M  
TRPA2511

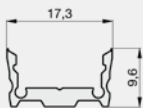

**PROFILE SMALL U**  
17.3/16/B1C1 1M  
TRPA2501

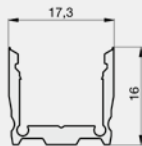

**PROFILE SMALL WING**  
25/13/B1C1 1M  
TRPA2521

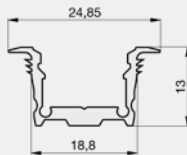

**PROFILE SMALL CORNER**  
22.8/22.8/B1C1 1M  
TRPA2531

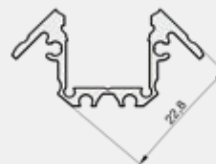

## Covers

**COVER SMALL F**  
16.4/4/C1 1M  
ZTPA2571

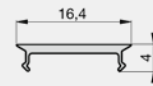

**COVER SMALL SQUARE**  
17/9/C1 1M  
ZTPA3111

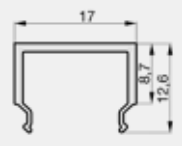

**PROFILE MEDIUM U FLAT**  
27/10.2/B2C2 1M  
TRPA2551

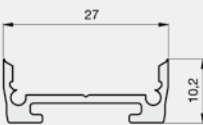

**PROFILE MEDIUM U**  
27/25.9/B2C2 1M  
TRPA2541

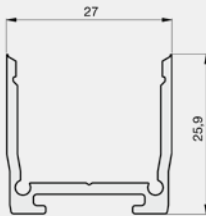

**PROFILE MEDIUM WING**  
40/25.9/B2C2 1M  
TRPA2561

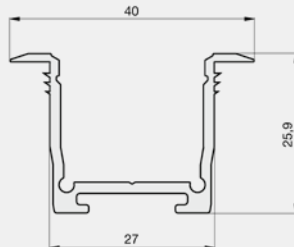

**COVER MEDIUM F**  
26/5/C2 1M  
ZTPA2591



**COVER MEDIUM SQUARE**  
27/14/C2 1M  
ZTPA3121

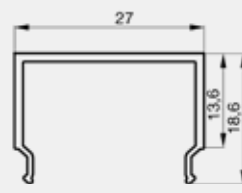

Please find further profiles, covers and accessories as well as product information on [page 58 ff.](#)

## Power Supply

**Not dimmable**  
**DRIVER FLAT 60W/24V**  
IP20 RADIUM  
OTNA3103



**Dimmable Phasecut**  
**DRIVER PHASECUT 75W/24V**  
IP20 RADIUM  
OTDA3026



**Dimmable DALI**  
**DRIVER DALI 1CH 75W/24V**  
IP20 RADIUM  
OTDA4071



**Dimmable Casambi (Bluetooth)**  
**DRIVER BT 1CH 60W/24V**  
IP20 TRIDONIC  
OTDA2444



**LED Essence Strip 1500**



5.0 m

**LED Essence Strip 1500**



6.2 m

**LED Essence Strip 1500**



6.2 m

**LED Essence Strip 1500**



5.0 m

Please refer to [page 80 ff.](#) for further information on control gears, dimmers and accessories.

Please refer to [page 88 ff.](#) for further information on control units.

# LED Essence Strip 700 ZeroPitch



## Product features:

- Very long lifespan: **50,000 h L70B50**
- Very good colour rendering: **CRI >90**
- Suitable for operation on **24 V DC**
- Wide beam angle: **160°**

## Advantages:

- Continuous light line
- Perfectly suited for use in super-flat profiles or for furniture installation
- Low glare compared to SMD LEDs

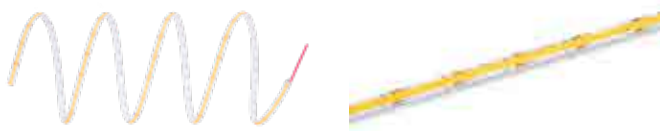

1



## LED Essence Strip 700 ZeroPitch

LED Essence Strip 700 ZeroPitch							mm	pcs.		
1	RSTA3825	LED STRIP 700ZP E 927/24V 5M	8.0	630	280		-	G	2	10
1	RSTA3835	LED STRIP 700ZP E 930/24V 5M	8.0	640	280		-	G	2	10
1	RSTA3845	LED STRIP 700ZP E 940/24V 5M	8.0	660	280		-	G	2	10
1	RSTA3855	LED STRIP 700ZP E 965/24V 5M	8.0	680	280		-	G	2	10



## Available lengths

Available lengths		mm	m	article no.
1	LED STRIP 700ZP E 927/24V 5M	25	5	RSTA3825
1	LED STRIP 700ZP E 930/24V 5M	25	5	RSTA3835
1	LED STRIP 700ZP E 940/24V 5M	25	5	RSTA3845
1	LED STRIP 700ZP E 965/24V 5M	25	5	RSTA3855

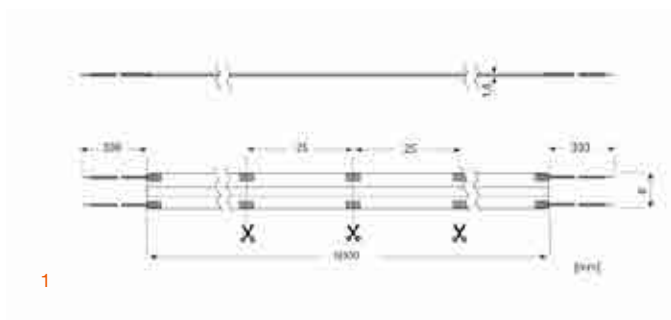

1

## Feed-in connector for LED Strips

**STRIP CON**  
**2PIN 8MM/50CM**  
 FXZA4460



Please refer to [page 54](#) for further product information.

### Profiles

**PROFILE SMALL U FLAT**  
**17.3/9.6/B1C1 1M**  
 TRPA2511

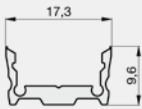

**PROFILE SMALL U**  
**17.3/16/B1C1 1M**  
 TRPA2501

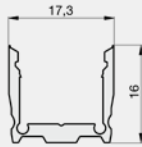

**PROFILE SMALL WING**  
**25/13/B1C1 1M**  
 TRPA2521

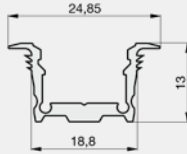

**PROFILE SMALL CORNER**  
**22.8/22.8/B1C1 1M**  
 TRPA2531

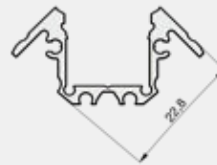

### Covers

**COVER SMALL F**  
**16.4/4/C1 1M**  
 ZTPA2571

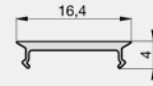

**COVER SMALL SQUARE**  
**17/9/C1 1M**  
 ZTPA3111

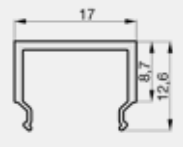

**PROFILE MEDIUM U FLAT**  
**27/10.2/B2C2 1M**  
 TRPA2551

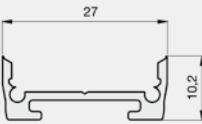

**PROFILE MEDIUM U**  
**27/25.9/B2C2 1M**  
 TRPA2541

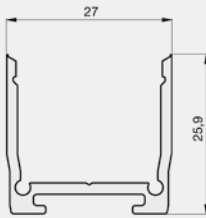

**PROFILE MEDIUM WING**  
**40/25.9/B2C2 1M**  
 TRPA2561

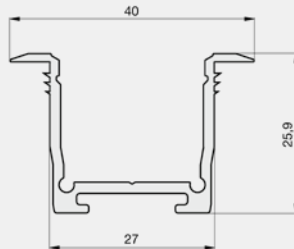

**COVER MEDIUM F**  
**26/5/C2 1M**  
 ZTPA2591

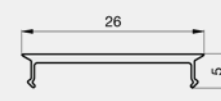

**COVER MEDIUM SQUARE**  
**27/14/C2 1M**  
 ZTPA3121

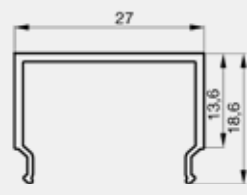

Please find further profiles, covers and accessories as well as product information on [page 58 ff.](#)

## Power Supply

**Not dimmable**

**DRIVER FLAT 60W/24V**  
**IP20 RADIUM**  
 OTNA3103



**Dimmable**  
**Phasecut**

**DRIVER PHASECUT 75W/24V**  
**IP20 RADIUM**  
 OTDA3026



**Dimmable DALI**

**DRIVER DALI 1CH 75W/24V**  
**IP20 RADIUM**  
 OTDA4071



**Dimmable Casambi (Bluetooth)**

**DRIVER BT 1CH 60W/24V**  
**IP20 TRIDONIC**  
 OTDA2444



**LED Essence Strip**  
**700 ZeroPitch**



7.5 m

**LED Essence Strip**  
**700 ZeroPitch**



9.3 m

**LED Essence Strip**  
**700 ZeroPitch**



9.3 m

**LED Essence Strip**  
**700 ZeroPitch**



7.5 m

Please refer to [page 80 ff.](#) for further information on control gears, dimmers and accessories.

Please refer to [page 88 ff.](#) for further information on control units.

# LED Essence Strip 1000 RGBW and 2200 Tunable White



## Product features RGBW:

- Long lifespan: **30,000 h L70B50**
- Dynamic coloured light by RGB LEDs
- Suitable for operation on **24 V DC**
- Optimal function with multi-channel LED dimmers

## Product features TW:

- Long lifespan: **50,000 h L70B50**
- Very good colour rendering: **CRI >90**
- Variable colour temperature: **2700–6500 K**
- Suitable for operation on **24 V DC**
- High efficiency of up to **116 lm/W**

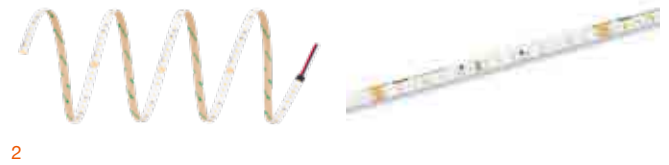

### LED Essence Strip 1000 RGBW

								mm	pcs.	
1	RSTA3635	LED STRIP 1000 E RGBW/24V 5M	19.2	960	60		16.7	-	5	10

### LED Essence Strip 2200 Tunable White

								mm	pcs.	
2	RSTA3645	LED STRIP 2200 E TW/24V 5M	19.2	2236	128		15.6	F	3	10

Note: For appropriate operation of the LED Strip, an aluminum profile is required for cooling.

### Available lengths

		mm	m	article no.
1	LED STRIP 1000 E RGBW/24V 5M	100	5	RSTA3635
2	LED STRIP 2200 E TW/24V 5M	125	5	RSTA3645

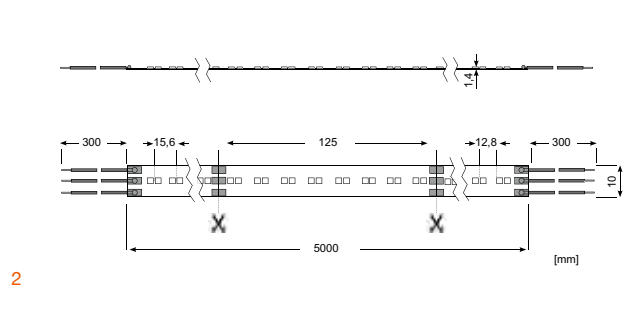
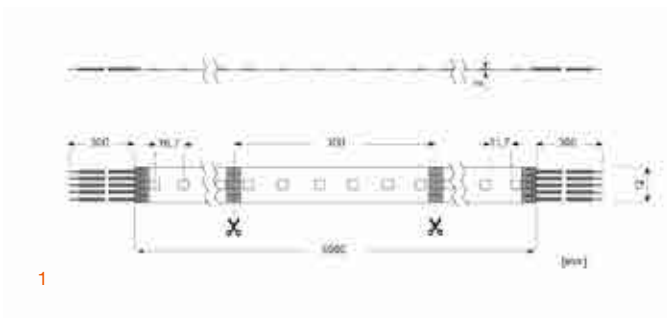

## Strip to strip connector

**STRIP CABLE BRIDGE**  
**5PIN 12MM/5CM 4PCS**  
**FXZA4511**

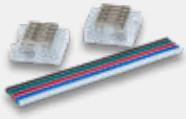

Please refer to page 54 for further product information.

\*Note: Not compatible with LED Essence Strip 2200 TW. Accessory compatibility on [page 56-57](#).

## Profiles

**PROFILE SMALL U FLAT**  
**17.3/9.6/B1C1 1M**  
**TRPA2511**

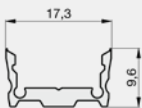

**PROFILE SMALL U**  
**17.3/16/B1C1 1M**  
**TRPA2501**

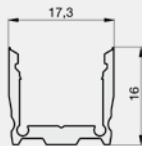

**PROFILE SMALL WING**  
**25/13/B1C1 1M**  
**TRPA2521**

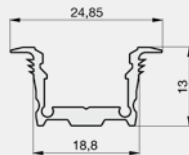

**PROFILE SMALL CORNER**  
**22.8/22.8/B1C1 1M**  
**TRPA2531**

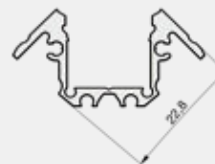

## Covers

**COVER SMALL F**  
**16.4/4/C1 1M**  
**ZTPA2571**

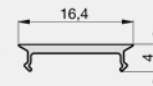

**COVER SMALL SQUARE**  
**17/9/C1 1M**  
**ZTPA3111**

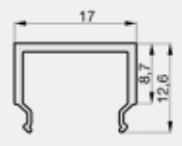

**PROFILE MEDIUM U FLAT**  
**27/10.2/B2C2 1M**  
**TRPA2551**

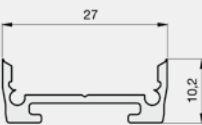

**PROFILE MEDIUM U**  
**27/25.9/B2C2 1M**  
**TRPA2541**

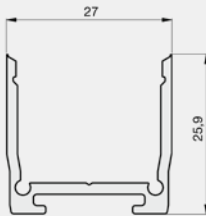

**PROFILE MEDIUM WING**  
**40/25.9/B2C2 1M**  
**TRPA2561**

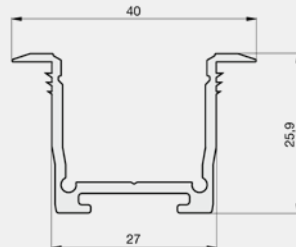

**COVER MEDIUM F**  
**26/5/C2 1M**  
**ZTPA2591**



**COVER MEDIUM SQUARE**  
**27/14/C2 1M**  
**ZTPA3121**

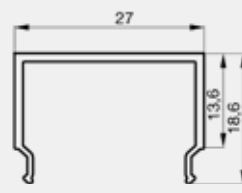

Please find further profiles, covers and accessories as well as product information on [page 58 ff](#).

## Power Supply

**Dimmable DALI**  
**DRIVER DALI 2CH 150W/24V**  
**IP20 RADIUM**  
**OTDA4075**



**LED Essence Strip RGBW** 7.8 m  
**LED Essence Strip TW** 7.8 m

**Dimmable DALI/DMX**  
**DRIVER DALI/DMX 4CH 150W/24V**  
**IP20 RADIUM**  
**OTDA4076**



**LED Essence Strip RGBW** 7.8 m  
**LED Essence Strip TW** 7.8 m

## Control Units

**Light control RF\***  
**DIMMER RF 4CH 480W/12-36V**  
**IP20**  
**LMRA3971**



**LED Essence Strip RGBW** 24.0 m  
**LED Essence Strip TW** 24.0 m

**Light control Casambi (PWM4)\***  
**CBU-PWM4-LR**  
**LMBA4969**



**LED Essence Strip RGBW** 7.5 m  
**LED Essence Strip TW** 7.5 m

Please refer to [page 80 ff](#). for further information on control gears, dimmers and accessories.

Please refer to [page 88 ff](#). for further information on control units.

\*Note: A 24V DC LED driver is required for operation.

# LED Essence Strip 400 and 1000 Waterproof



## Product features:

- Very long lifespan: **50,000 h L70B50**
- Very good colour rendering: **CRI >90**
- Suitable for operation on **24 V DC**
- High colour consistency: **SDCM <3**
- High protection class thanks to silicone extrusion: **IP66**
- Connecting cable on both sides: **300 mm**



1



## LED Essence Strip 400 Waterproof

							mm		pcs.	
1	RSTA3655	LED STRIP 400 E 927/24V/IP66 5M	3.6	424	80	●	12.5	F	2	10
1	RSTA3665	LED STRIP 400 E 930/24V/IP66 5M	3.6	431	80	●	12.5	E	2	10
1	RSTA3675	LED STRIP 400 E 940/24V/IP66 5M	3.6	460	80	○	12.5	E	2	10
1	RSTA3685	LED STRIP 400 E 965/24V/IP66 5M	3.6	451	80	●	12.5	E	2	10

## LED Essence Strip 1000 Waterproof

1	RSTA3695	LED STRIP 1000 E 927/24V/IP66 5M	8.0	912	80	●	12.5	F	2	10
1	RSTA3705	LED STRIP 1000 E 930/24V/IP66 5M	8.0	927	80	●	12.5	F	2	10
1	RSTA3715	LED STRIP 1000 E 940/24V/IP66 5M	8.0	988	80	○	12.5	E	2	10
1	RSTA3725	LED STRIP 1000 E 965/24V/IP66 5M	8.0	996	80	●	12.5	E	2	10



## Available lengths

			mm	m	article no.
1	LED STRIP 400 E 927/24V/IP66 5M		100	7.0	RSTA3655
1	LED STRIP 400 E 930/24V/IP66 5M		100	7.0	RSTA3665
1	LED STRIP 400 E 940/24V/IP66 5M		100	7.0	RSTA3675
1	LED STRIP 400 E 965/24V/IP66 5M		100	7.0	RSTA3685
1	LED STRIP 1000 E 927/24V/IP66 5M		100	5.5	RSTA3695
1	LED STRIP 1000 E 930/24V/IP66 5M		100	5.5	RSTA3705
1	LED STRIP 1000 E 940/24V/IP66 5M		100	5.5	RSTA3715
1	LED STRIP 1000 E 965/24V/IP66 5M		100	5.5	RSTA3725

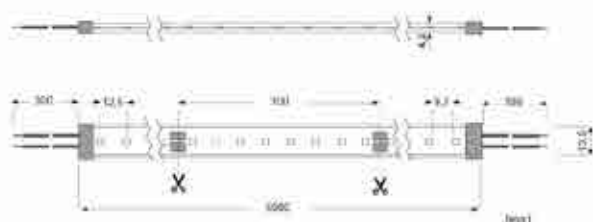

1



## Feed-in connector for LED Strips

**STRIP CON SD 2PIN**  
**8MM/50CM IP65**  
**FXZA2473**



Please refer to [page 54](#) for further product information.

### Profiles

**PROFILE SMALL U FLAT**  
**17.3/9.6/B1C1 1M\***  
**TRPA2511**

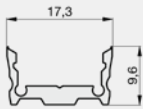

**PROFILE SMALL U**  
**17.3/16/B1C1 1M**  
**TRPA2501**

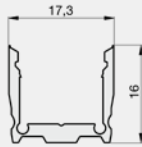

**PROFILE SMALL WING**  
**25/13/B1C1 1M**  
**TRPA2521**

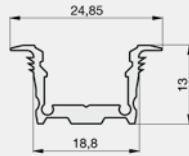

**PROFILE SMALL CORNER**  
**22.8/22.8/B1C1 1M**  
**TRPA2531**

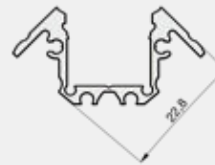

### Covers

**COVER SMALL F**  
**16.4/4/C1 1M**  
**ZTPA2571**

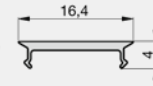

**COVER SMALL SQUARE**  
**17/9/C1 1M**  
**ZTPA3111**

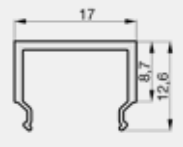

**PROFILE MEDIUM U FLAT**  
**27/10.2/B2C2 1M\***  
**TRPA2551**

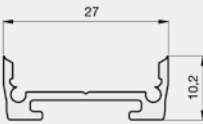

**PROFILE MEDIUM U**  
**27/25.9/B2C2 1M**  
**TRPA2541**

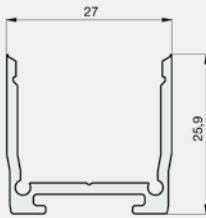

**PROFILE MEDIUM WING**  
**40/25.9/B2C2 1M**  
**TRPA2561**

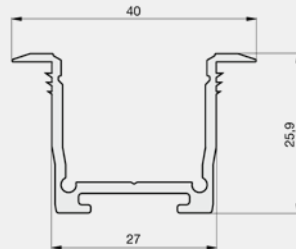

**COVER MEDIUM F**  
**26/5/C2 1M**  
**ZTPA2591**

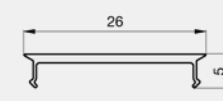

**COVER MEDIUM SQUARE**  
**27/14/C2 1M**  
**ZTPA3121**

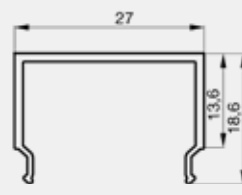

Please find further profiles, covers and accessories as well as product information on [page 58 ff.](#)

\*Only compatible with waterproof LED Strips without cover.

## Power Supply

**Not dimmable**  
**DRIVER 40W/24V**  
**IP66 OSRAM**  
**OTNA2420**



**Not dimmable**  
**DRIVER 75W/24V**  
**IP67 MeanWell**  
**OTDA2450**



**Dimmable 1-10V**  
**DRIVER 1-10V 40W/24V**  
**IP66 OSRAM**  
**OTDA2425**



**Dimmable DALI**  
**DRIVER DALI 4CH 100W/24V**  
**IP67 OSRAM**  
**OTDA4107**



**LED Essence Strip 400 IP66**  
**LED Essence Strip 800 IP66**

11.1 m  
 5.0 m

**LED Essence Strip 400 IP66**  
**LED Essence Strip 800 IP66**

20.8 m  
 9.3 m

**LED Essence Strip 400 IP66**  
**LED Essence Strip 800 IP66**

11.1 m  
 5.0 m

**LED Essence Strip 400 IP66**  
**LED Essence Strip 800 IP66**

27.7 m  
 12.5 m



Please refer to [page 80 ff.](#) for further information on control gears, dimmers and accessories.

Please refer to [page 88 ff.](#) for further information on control units.

# LED Essence Strip 1400 Waterproof



## Product features:

- Very long lifespan: **50,000 h L70B50**
- Very good colour rendering: **CRI >90**
- Suitable for operation on **24 V DC**
- High colour consistency: **SDCM <3**
- High protection class thanks to silicone extrusion: **IP66**
- Connecting cable on both sides: **300 mm**



1



## LED Essence Strip 1400 Waterproof

							mm		pcs.	
1	RSTA3735	<b>LED STRIP 1400 E 927/24V/IP66 5M</b>	12.0	1368	80	●	12.5	F	2	10
1	RSTA3745	<b>LED STRIP 1400 E 930/24V/IP66 5M</b>	12.0	1379	80	●	12.5	F	2	10
1	RSTA3755	<b>LED STRIP 1400 E 940/24V/IP66 5M</b>	12.0	1459	80	○	12.5	E	2	10
1	RSTA3765	<b>LED STRIP 1400 E 965/24V/IP66 5M</b>	12.0	1448	80	●	12.5	E	2	10



## Available lengths

		mm	m	article no.
1	<b>LED STRIP 1400 E 927/24V/IP66 5M</b>	100	5	RSTA3735
1	<b>LED STRIP 1400 E 930/24V/IP66 5M</b>	100	5	RSTA3745
1	<b>LED STRIP 1400 E 940/24V/IP66 5M</b>	100	5	RSTA3755
1	<b>LED STRIP 1400 E 965/24V/IP66 5M</b>	100	5	RSTA3765

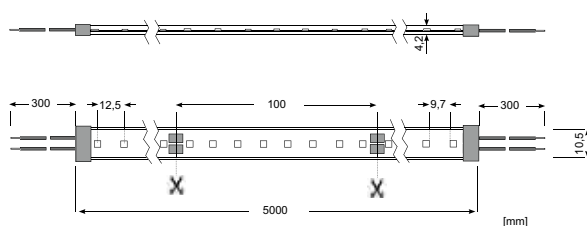

1

## Feed-in connector for LED Strips

**STRIP CON SD 2PIN**  
**8MM/50CM IP65**  
**FXZA2473**



Please refer to [page 54](#) for further product information.

### Profiles

**PROFILE SMALL U FLAT**  
**17.3/9.6/B1C1 1M\***  
**TRPA2511**

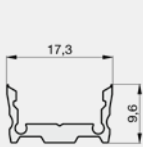

**PROFILE SMALL U**  
**17.3/16/B1C1 1M**  
**TRPA2501**

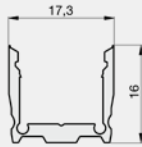

**PROFILE SMALL WING**  
**25/13/B1C1 1M**  
**TRPA2521**

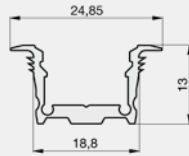

**PROFILE SMALL CORNER**  
**22.8/22.8/B1C1 1M**  
**TRPA2531**

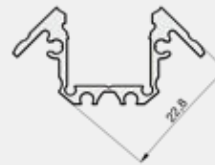

### Covers

**COVER SMALL F**  
**16.4/4/C1 1M**  
**ZTPA2571**

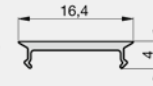

**COVER SMALL SQUARE**  
**17/9/C1 1M**  
**ZTPA3111**

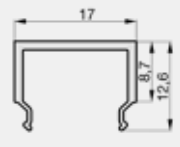

**PROFILE MEDIUM U FLAT**  
**27/10.2/B2C2 1M\***  
**TRPA2551**

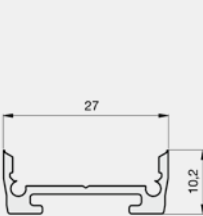

**PROFILE MEDIUM U**  
**27/25.9/B2C2 1M**  
**TRPA2541**

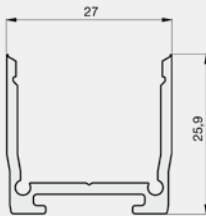

**PROFILE MEDIUM WING**  
**40/25.9/B2C2 1M**  
**TRPA2561**

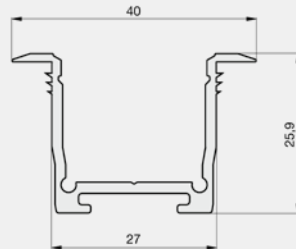

**COVER MEDIUM F**  
**26/5/C2 1M**  
**ZTPA2591**

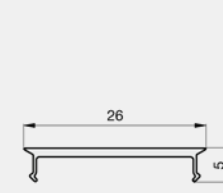

**COVER MEDIUM SQUARE**  
**27/14/C2 1M**  
**ZTPA3121**

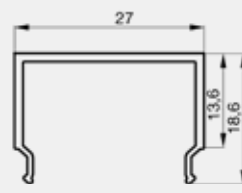

Please find further profiles, covers and accessories as well as product information on [page 58 ff.](#)

\*Only compatible with waterproof LED Strips without cover.

### Power Supply

**Not dimmable**  
**DRIVER 75W/24V**  
**IP67 MeanWell**  
**OTDA2450**



**Dimmable 1-10V**  
**DRIVER 1-10V 60W/24V**  
**IP66 OSRAM**  
**OTDA2426**



**Dimmable DALI**  
**DRIVER DALI 4CH 100W/24V**  
**IP67 OSRAM**  
**OTDA4107**



### Control Unit

**Light control Casambi (PWM4)\***  
**CBU-PWM4-LR**  
**LMBA4969**



**LED Essence Strip 1400 IP66** 6.2 m **LED Essence Strip 1400 IP66** 5.0 m **LED Essence Strip 1400 IP66** 8.3 m **LED Essence Strip 1400 IP66** 12.0 m



Please refer to [page 80 ff.](#) for further information on control gears, dimmers and accessories.

Please refer to [page 88 ff.](#) for further information on control units.

\*Note: A 24V DC LED driver is required for operation.

# LED Essence Strip 500 RGBW Waterproof



## Product features:

- Long lifespan: **30,000 h L70B50**
- Dynamic coloured light by RGB LEDs
- Suitable for operation on **24 V DC**
- High protection thanks to silicone extrusion: **IP66**
- Connecting cable on both sides: **300 mm**



1



## LED Essence Strip 500 RGBW Waterproof

						mm		pcs.	
1	RSTA3775	<b>LED STRIP 900 E RGBW/24V/IP66 5M</b>	19.2	912	60		16.7	5	10

**Note:** For appropriate operation of the LED Strip, an aluminum profile is required for cooling.



## Available lengths

		mm	m	article no.
1	<b>LED STRIP 900 E RGBW/24V/IP66 5M</b>	100	5	RSTA3775

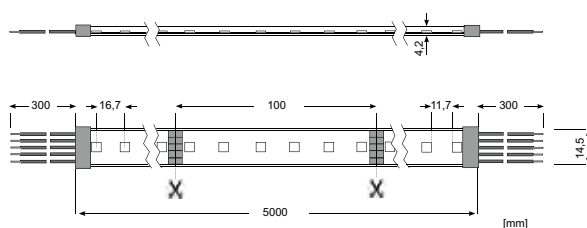

1

## Feed-in cables pre-assembled on both sides

Our waterproof LED Essence RGBW Strip, like all LED Strips from our Essence portfolio, is provided with a 0.3 m connection cable on each side.

## Profiles

The anodised MEDIUM aluminium profiles offer a high-quality design and optimum protection for the waterproof LED Essence Strip RGBW. Benefit from a large light emission area – especially in combination with our SQUARE cover.

**PROFILE MEDIUM U FLAT**  
27/10.2/B2C2 1M\*  
TRPA2551

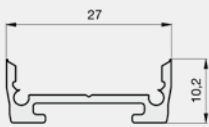

**PROFILE MEDIUM U**  
27/25.9/B2C2 1M  
TRPA2541

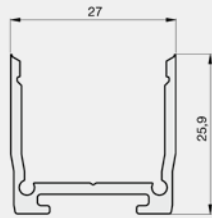

**PROFILE MEDIUM WING**  
40/25.9/B2C2 1M  
TRPA2561

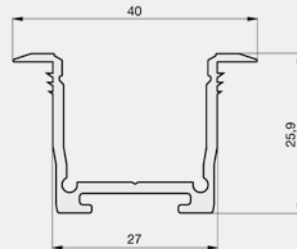

## Covers

**COVER MEDIUM F**  
26/5/C2 1M  
ZTPA2591



**COVER MEDIUM SQUARE**  
27/14/C2 1M  
ZTPA3121

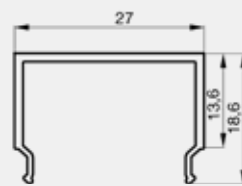

Please find further profiles, covers and accessories as well as product information on [page 58 ff.](#)

\*Only compatible with waterproof LED Strips without cover.

## Power Supply

**Dimmable DALI**  
DRIVER DALI 4CH 210W/24V  
IP67 OSRAM  
OTDA2461



**LED Essence Strip**  
500 RGBW IP66



10.9 m

**Dimmable DALI**  
DRIVER DALI 4CH 100W/24V  
IP67 OSRAM  
OTDA4107



**LED Essence Strip**  
500 RGBW IP66



5.2 m

**Dimmable DALI/DMX**  
DRIVER DALI/DMX 4CH 150W/24V  
IP20 RADIUM  
OTDA4076



**LED Essence Strip**  
500 RGBW IP66



7.8 m

## Control Unit

**Light control Casambi (PWM4)\***  
CBU-PWM4-LR  
LMBA4969



**LED Essence Strip**  
500 RGBW IP66



7.5 m

Please refer to [page 80 ff.](#) for further information on control gears, dimmers and accessories.

Please refer to [page 88 ff.](#) for further information on control units.

\*Note: A 24V DC LED driver is required for operation.

## Accessories for LED Strips



### Feed-in connector for LED Strips

			mm	mm		pcs.	
1	FXZA2470	STRIP CON CP 2PIN 8MM/50CM	2	8	500	IP00	5
2	FXZA2471	STRIP CON CP 4PIN 10MM/50CM	4	10	500	IP00	5
3	FXZA2479	STRIP CON SD 2PIN 8MM/SW*	2	8	-	IP00	5
4	FXZA2473	STRIP CON SD 2PIN 8MM/50CM IP65	2	8	500	IP65	5
5	FXZA4460	STRIP CON 2PIN 8MM/50CM	2	8	500	IP00	5
5	FXZA4461	STRIP CON 2PIN 10MM/50CM	2	10	500	IP00	5

\*Note: Cable not included. For use with your own cable (0.3–0.5 mm<sup>2</sup>).



### Strip to strip connector

			mm	mm		pcs.	
1	FXZA2477	STRIP CABLE BRIDGE CP 2PIN 8MM/5CM	2	8	50	IP00	5
2	FXZA2478	STRIP CABLE BRIDGE CP 4PIN 10MM/5CM	4	10	50	IP00	5
3	FXZA4510	STRIP CABLE BRIDGE 2PIN 10MM/5CM 4PCS	2	10	50	IP00	10
4	FXZA4511	STRIP CABLE BRIDGE 5PIN 12MM/5CM 4PCS	5	12	50	IP00	10
5	FXZA2475	STRIP BRIDGE CP 2PIN 8MM	2	8	-	IP00	5
6	FXZA2476	STRIP BRIDGE CP 4PIN 10MM	4	10	-	IP00	5

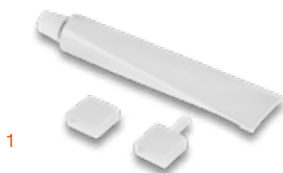

### Accessories for waterproof LED Strips

						pcs.	
1	FXZA2631	STRIP WATERPROOF KIT RGB				IP67	1

Each kit contains:

- 1 tube of silicone
- 5 end caps with opening for supply line
- 5 end caps without opening



# Accessories for LED Strips



## LED Strip cables

FXZA4120	RIBBON CABLE 2x0.32mm <sup>2</sup> IND		2	0.32
FXZA4122	RIBBON CABLE 2x0.82mm <sup>2</sup> IND		2	0.82
FXZA4123	RIBBON CABLE 3x0.32mm <sup>2</sup> IND		3	0.32
FXZA4124	RIBBON CABLE 4x0.32mm <sup>2</sup> IND		4	0.32
FXZA4125	RIBBON CABLE 5x0.32mm <sup>2</sup> IND		5	0.32
FXZA4126	SHEATHED CABLE 2x0.32mm <sup>2</sup> IND		2	0.32
FXZA4127	SHEATHED CABLE 2x0.52mm <sup>2</sup> IND		2	0.52
FXZA4128	SHEATHED CABLE 2x0.82mm <sup>2</sup> IND		2	0.82



## LED Strip connector systems

1	FXZA3995	CABLE PLUG 2PIN P1 IP20	9	0.55	36		2	1	IP20
2	FXZA3996	POWER DISTRIBUTOR 2PORT P1 IP20	6	-	36		2	2	IP20
3	FXZA3997	POWER DISTRIBUTOR 4PORT P1 IP20	6	-	36		2	4	IP20
4	FXZA3998	CABLE BRIDGE T-SHAPE 2PIN IP20	9	0.55	300		2	3	IP20
5	FXZA3999	CABLE BRIDGE I-SHAPE 2PIN IP20	9	0.55	300		2	2	IP20

Wiring diagram: POWER DISTRIBUTOR 4PORT

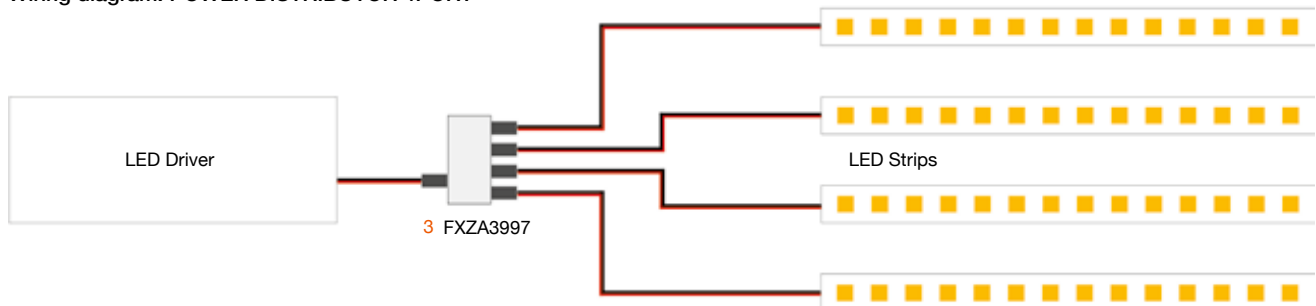









# Compatibility of Accessories

## Product family





Page

LED Star Strip 400 / 900	20
LED Star Strip 1400 / 2200	22
LED Star Strip 3000	24
LED Star Strip ZeroPitch	26
LED Star Strip ZeroPitch Furniture	26
LED Star Strip WarmDIM	30
LED Star Strip 400 / 800 Waterproof	34
LED Star Strip 1300 / 2000 Waterproof	36
LED Essence Strip 500 / 1000	40
LED Essence Strip 1500	42
LED Essence Strip ZeroPitch	44
LED Essence Strip 400 / 1000 Waterproof	48
LED Essence Strip 1400 Waterproof	50

Product Name	LED Star Strip 400 / 900	LED Star Strip 1400 / 2200	LED Star Strip 3000	LED Star Strip ZeroPitch	LED Star Strip ZeroPitch Furniture	LED Star Strip WarmDIM	LED Star Strip 400 / 800 Waterproof	LED Star Strip 1300 / 2000 Waterproof	LED Essence Strip 500 / 1000	LED Essence Strip 1500	LED Essence Strip ZeroPitch	LED Essence Strip 400 / 1000 Waterproof	LED Essence Strip 1400 Waterproof
<b>STRIP CON CP 2PIN 8MM/50CM</b> FXZA2470 									X	X			
<b>STRIP CON 2PIN 8MM/50CM</b> FXZA4460 				X					X	X	X		
<b>STRIP CON 2PIN 10MM/50CM</b> FXZA4461 	X	X	X			X							
<b>STRIP CON SD 2PIN 8MM/50CM IP65</b> FXZA2473 												X	X
<b>STRIP CON SD 2PIN 8MM/SW</b> FXZA2479 									X	X			
<b>STRIP CABLE BRIDGE CP 2PIN 8MM/5CM</b> FXZA2477 									X	X			
<b>STRIP CABLE BRIDGE 2PIN 10MM/5CM 4PCS</b> FXZA4510 	X	X	X			X							
<b>STRIP BRIDGE CP 2PIN 8MM</b> FXZA2475 									X	X			

# Compatibility of Accessories

## Product family

Page	LED Star Strip Tunable White	LED Star Strip RGB	LED Star Strip RGBW	LED Star Strip RGB Waterproof	LED Essence Strip RGBW	LED Essence Strip Tunable White	LED Essence Strip RGBW Waterproof
<b>STRIP CON CP 4PIN 10MM/50CM</b> FXZA2471 		X					
<b>STRIP CABLE BRIDGE CP 4PIN 10MM/5CM</b> FXZA2478 		X					
<b>STRIP CABLE BRIDGE 5PIN 12MM/5CM 4PCS</b> FXZA4511 			X		X		
<b>STRIP BRIDGE CP 4PIN 10MM</b> FXZA2476 		X					
<b>STRIP WATERPROOF KIT RGB</b> FXZA2631 				X			

Products.

## Profiles and Covers.

For the installation of our flexible LED Strips, we offer you a variable and versatile range of accessories for every installation situation. Our high-class aluminum profiles with fitting covers and the necessary mounting accessories provide a perfectly coordinated system of high quality. You will find the ideal combination for a lot of different requirements to develop timeless, efficient and reliable lighting systems in our portfolio.

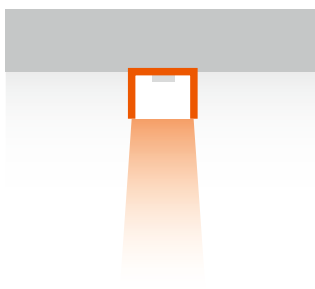

Ceiling and wall mounting

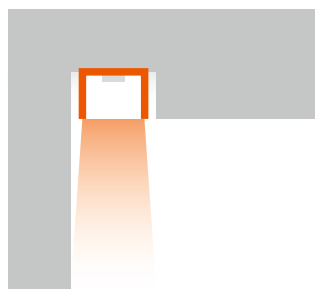

Wall cover  
Stairs lighting

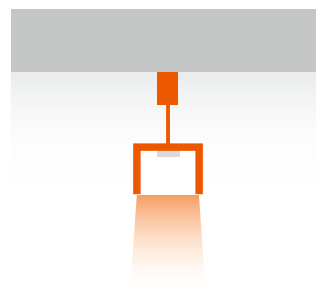

Suspended luminaires

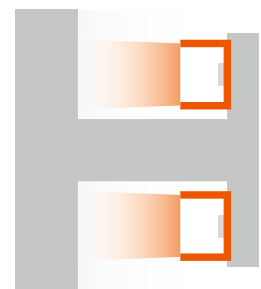

Backlighting

# Content

PROFILE SMALL U	60
PROFILE SMALL U FLAT	62
PROFILE SMALL CORNER	64
PROFILE SMALL WING	66
PROFILE MEDIUM U	68
PROFILE MEDIUM U FLAT	70
PROFILE MEDIUM WING	72
Accessories	74
Compatibility of Accessories	78

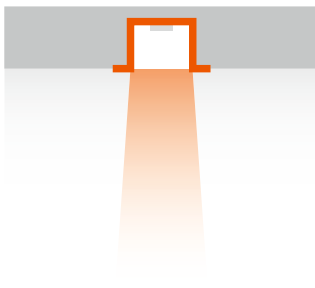
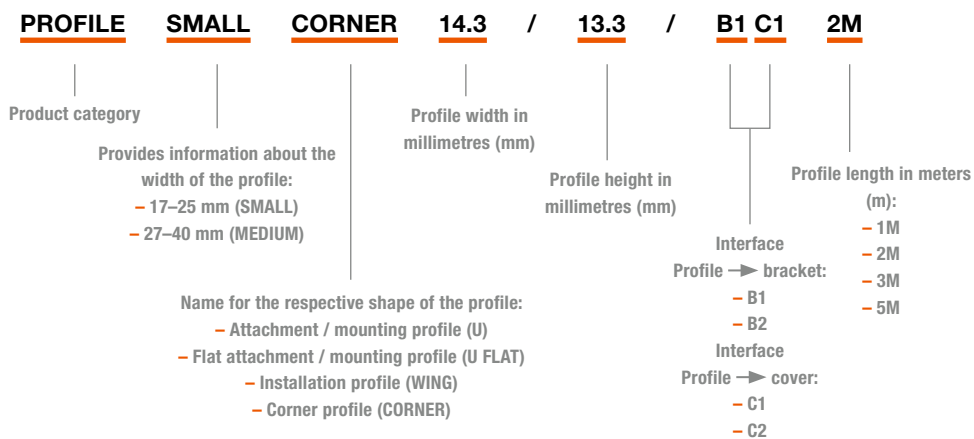

Ceiling and furniture installation



Sublighting under surface



Wall cove  
Cabinet / Showcase lighting



Ceiling cove

## Attachment Profile SMALL U

### Product features:

- High quality anodized aluminum profile with almost rimless light emission surface
- Extra thick base for the use of countersunk screws and for optimal heat dissipation
- Versatile installation options
- Simple and timeless design
- Optimal cooling and protection for LED Strips



### Mounting:

- Installation with mounting brackets
- Installation by screwing
- Wire suspension



### Available lengths

article no.

article no.

article no.

#### Profiles

	1 m	2 m	3 m
1 PROFILE SMALL U 17.3/16/B1C1	TRPA2501	TRPA2502	TRPA2503
2 PROFILE S U 17.3/16/B1C1 WHITE	-	TRPA4210	-
3 PROFILE S U 17.3/16/B1C1 BLACK	-	TRPA4211	-

#### Covers

	1 m	2 m	3 m
COVER SMALL C 16.4/4/C1	ZTPA2581	ZTPA2582	ZTPA2583
COVER SMALL F 16.4/4/C1*	ZTPA2571	ZTPA2572	ZTPA2573
COVER SMALL BLACK 16.4/4 C1	-	ZTPA4472	-
COVER SMALL SQUARE 17/9 C1	ZTPA3111	ZTPA3112	ZTPA3113

\*Info: Also available in 20 m length, see [page 75](#).





1



2



3

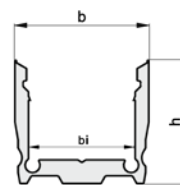

## PROFILE SMALL U

l (mm)    b (mm)    h (mm)    bi (mm)    pcs.



1	TRPA2501	<b>PROFILE SMALL U 17.3/16/B1C1 1M</b>	1010	17.3	16.0	13.5	C1	B1	10
1	TRPA2502	<b>PROFILE SMALL U 17.3/16/B1C1 2M</b>	2010	17.3	16.0	13.5	C1	B1	10
2	TRPA4210	<b>PROFILE S U 17.3/16/B1C1 2M WHITE</b>	2010	17.3	16.0	13.5	C1	B1	10
3	TRPA4211	<b>PROFILE S U 17.3/16/B1C1 2M BLACK</b>	2010	17.3	16.0	13.5	C1	B1	10
1	TRPA2503	<b>PROFILE SMALL U 17.3/16/B1C1 3M</b>	3010	17.3	16.0	13.5	C1	B1	10
1	TRPA2505	<b>PROFILE SMALL U 17.3/16/B1C1 5M*</b>	5010	17.3	16.0	13.5	C1	B1	10

\*Note: Available on request

## Fitting covers

Clear

**COVER SMALL C 16.4/4/C1**  
ZTPA2581, ZTPA2582,  
ZTPA2583\*

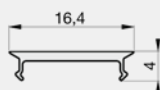

Frosted

**COVER SMALL F 16.4/4/C1**  
ZTPA2571, ZTPA2572,  
ZTPA2573\*

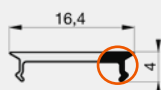

Frosted

**COVER SMALL SQUARE 17/9 C1**  
ZTPA3111, ZTPA3112,  
ZTPA3113\*

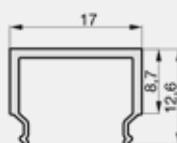

## Fitting end caps

Plastic

**ENDCAP PROFILE SMALL U**  
ZTPA2610



Plastic

**ENDCAP SQUARE PROFILE SMALL U**  
ZTPA3190



## Fitting mounting accessories

Plastic mounting bracket

**BRACKET PROFILE SMALL PLT B1**

ZTPA2620



Metal mounting bracket

**BRACKET PROFILE SMALL MET B1**

ZTPA2621



Wire suspension

**SUSPENSION KIT PROFILE SMALL 2M 2PCS**

ZTPA4576



Wire suspension live

**SUSPENSION KIT POWER PROFILE S B1 2M**

ZTPA3021



For details on profile accessories, refer to [page 75 ff.](#)

\*Info: The product is available in three standard lengths (1 m, 2 m, 3 m). The last digit of the article number represents the length in meters. Special lengths on request.

## Attachment Profile SMALL U FLAT

### Product features:

- High quality anodized aluminum profile with almost rimless light emission surface
- Extra thick base for the use of countersunk screws and for optimal heat dissipation
- Versatile installation options
- Simple and timeless design
- Optimal cooling and protection for LED Strips



### Mounting:

- Installation with mounting brackets
- Installation by screwing
- Wire suspension



article no.



article no.



article no.

### Available lengths

#### Profiles

	1 m	2 m	3 m
	article no.	article no.	article no.
1 PROFILE SMALL U FLAT 17.3/9.6/B1C1	TRPA2511	TRPA2512	TRPA2513
2 PROFILE S U FLAT 17.3/9.6/B1C1 WHITE	-	TRPA4212	-
3 PROFILE S U FLAT 17.3/9.6/B1C1 BLACK	-	TRPA4213	-

#### Covers

COVER SMALL C 16.4/4/C1	ZTPA2581	ZTPA2582	ZTPA2583
COVER SMALL F 16.4/4/C1*	ZTPA2571	ZTPA2572	ZTPA2573
COVER SMALL BLACK 16.4/4 C1	-	ZTPA4472	-
COVER SMALL SQUARE 17/9 C1	ZTPA3111	ZTPA3112	ZTPA3113

\*Info: Also available in 20 m length, see [page 75](#).



1



2



3

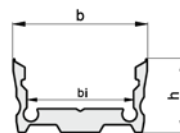

## PROFILE SMALL U FLAT

l (mm)    b (mm)    h (mm)    bi (mm)    pcs.



1	TRPA2511	PROFILE SMALL U FLAT 17.3/9.6/B1C1 1M	1010	17.3	9.6	13.5	C1	B1	10
1	TRPA2512	PROFILE SMALL U FLAT 17.3/9.6/B1C1 2M	2010	17.3	9.6	13.5	C1	B1	10
2	TRPA4212	PROFILE S U FLAT 17.3/9.6/B1C1 2M WHITE	2010	17.3	9.6	13.5	C1	B1	10
3	TRPA4213	PROFILE S U FLAT 17.3/9.6/B1C1 2M BLACK	2010	17.3	9.6	13.5	C1	B1	10
1	TRPA2513	PROFILE SMALL U FLAT 17.3/9.6/B1C1 3M	3010	17.3	9.6	13.5	C1	B1	10
1	TRPA2515	PROFILE SMALL U FLAT 17.3/9.6/B1C1 5M*	5010	17.3	9.6	13.5	C1	B1	10

\*Note: Available on request

## Fitting covers

Clear

**COVER SMALL C 16.4/4/C1**  
ZTPA2581, ZTPA2582,  
ZTPA2583\*

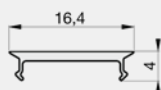

Frosted

**COVER SMALL F 16.4/4/C1**  
ZTPA2571, ZTPA2572,  
ZTPA2573\*

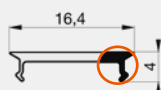

Frosted

**COVER SMALL SQUARE 17/9 C1**  
ZTPA3111, ZTPA3112,  
ZTPA3113\*

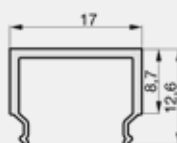

## Fitting end caps

Plastic

**ENDCAP PROFILE SMALL U FLAT**  
ZTPA2611



Plastic

**ENDCAP SQUARE PROFILE SMALL U FLAT**  
ZTPA3191



## Fitting mounting accessories

Plastic mounting bracket

**BRACKET PROFILE SMALL PLT B1**

ZTPA2620



Metal mounting bracket

**BRACKET PROFILE SMALL MET B1**

ZTPA2621



Wire suspension

**SUSPENSION KIT PROFILE SMALL 2M 2PCS**

ZTPA4576



Wire suspension live

**SUSPENSION KIT POWER PROFILE S B1 2M**

ZTPA3021



For details on profile accessories, refer to [page 75 ff.](#)

\*Info: The product is available in three standard lengths (1 m, 2 m, 3 m). The last digit of the article number represents the length in meters. Special lengths on request.

## Attachment Profile SMALL CORNER

### Product features:

- High quality anodized aluminum profile with almost rimless light emission surface
- Extra thick base for the use of countersunk screws and for optimal heat dissipation
- Versatile installation options
- Simple and timeless design
- Optimal cooling and protection for LED Strips

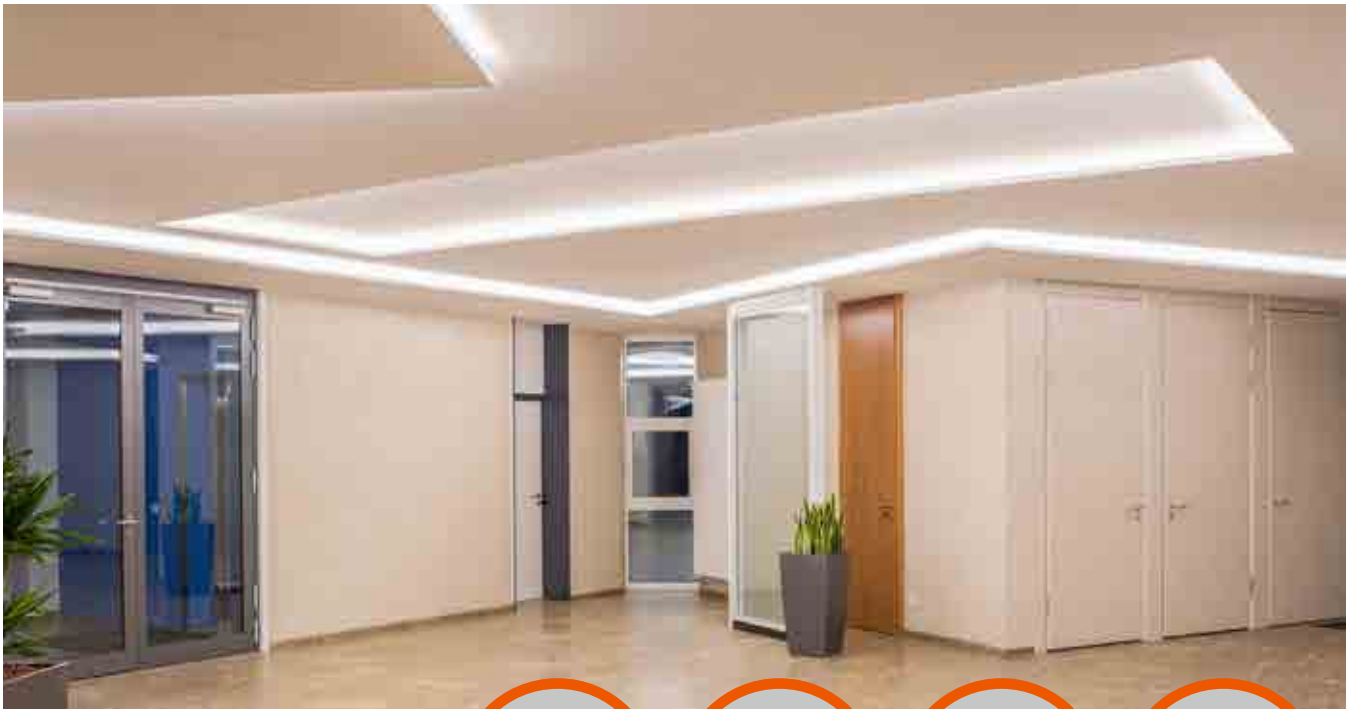

### Mounting:

- Installation with mounting brackets
- Installation by screwing



article no.



article no.



article no.

### Available lengths

#### Profiles

1 **PROFILE SMALL CORNER 22.8/22.8/B1C1**

TRPA2531

TRPA2532

TRPA2533

#### Covers

**COVER SMALL C 16.4/4/C1**

ZTPA2581

ZTPA2582

ZTPA2583

**COVER SMALL F 16.4/4/C1\***

ZTPA2571

ZTPA2572

ZTPA2573

\*Info: Also available in 20 m length, see [page 75](#).



1

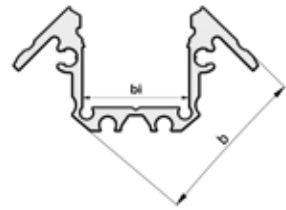

## PROFILE SMALL CORNER

l (mm)

b (mm)

b1 (mm)

pcs.



1	TRPA2531	<b>PROFILE SMALL CORNER 22.8/22.8/B1C1 1M</b>	1010	22.8	13.5	C1	B1	8
1	TRPA2532	<b>PROFILE SMALL CORNER 22.8/22.8/B1C1 2M</b>	2010	22.8	13.5	C1	B1	8
1	TRPA2533	<b>PROFILE SMALL CORNER 22.8/22.8/B1C1 3M</b>	3010	22.8	13.5	C1	B1	8
1	TRPA2535	<b>PROFILE SMALL CORNER 22.8/22.8/B1C1 5M*</b>	5010	22.8	13.5	C1	B1	8

\*Note: Available on request

### Fitting covers

Clear

**COVER SMALL C 16.4/4/C1**  
ZTPA2581, ZTPA2582,  
ZTPA2583\*

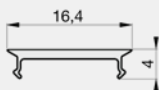

Frosted

**COVER SMALL F 16.4/4/C1**  
ZTPA2571, ZTPA2572,  
ZTPA2573\*

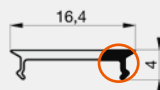

### Fitting end caps

Plastic

**ENDCAP PROFILE SMALL CORNER**  
ZTPA2613



### Fitting mounting accessories

Plastic mounting bracket

**BRACKET PROFILE SMALL PLT B1**  
ZTPA2620



Metal mounting bracket

**BRACKET PROFILE SMALL MET B1**  
ZTPA2621



For details on profile accessories, refer to [page 75 ff.](#)

\*Info: The product is available in three standard lengths (1 m, 2 m, 3 m). The last digit of the article number represents the length in meters. Special lengths on request.

## Installation Profile SMALL WING

### Product features:

- High quality anodized aluminum profile
- Extra thick base for the use of countersunk screws and for optimal heat dissipation
- Optimized for installation e.g. in suspended ceilings and furniture
- Simple and timeless design
- Optimal cooling and protection for LED Strips



### Mounting:

- Installation with mounting brackets
- Installation by screwing
- Installation by clamping and glueing



article no.



article no.



article no.

### Available lengths

#### Profiles

	1 m	2 m	3 m
	article no.	article no.	article no.
1 PROFILE SMALL WING 25/13/B1C1	TRPA2521	TRPA2522	TRPA2523
2 PROFILE S WING 25/13/B1C1 WHITE	-	TRPA4214	-
3 PROFILE S WING 25/13/B1C1 BLACK	-	TRPA4215	-

#### Covers

COVER SMALL C 16.4/4/C1	ZTPA2581	ZTPA2582	ZTPA2583
COVER SMALL F 16.4/4/C1*	ZTPA2571	ZTPA2572	ZTPA2573
COVER SMALL BLACK 16.4/4 C1	-	ZTPA4472	-

\*Info: Also available in 20 m length, see [page 75](#).



1



2



3

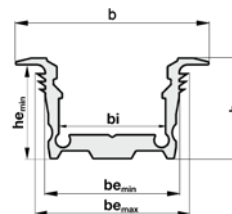

## PROFILE SMALL WING

l (mm)   b (mm)   h (mm)   bi (mm)   be<sub>min</sub> (mm)   be<sub>max</sub> (mm)   he<sub>min</sub> (mm)   pcs.



1	TRPA2521	<b>PROFILE SMALL WING 25/13/B1C1 1M</b>	1010	24.8	13.0	13.5	17.3	18.8	12.5	C1	B1	10
1	TRPA2522	<b>PROFILE SMALL WING 25/13/B1C1 2M</b>	2010	24.8	13.0	13.5	17.3	18.8	12.5	C1	B1	10
2	TRPA4214	<b>PROFILE S WING 25/13/B1C1 2M WHITE</b>	2010	24.8	13.0	13.5	17.3	18.8	12.5	C1	B1	10
3	TRPA4215	<b>PROFILE S WING 25/13/B1C1 2M BLACK</b>	2010	24.8	13.0	13.5	17.3	18.8	12.5	C1	B1	10
1	TRPA2523	<b>PROFILE SMALL WING 25/13/B1C1 3M</b>	3010	24.8	13.0	13.5	17.3	18.8	12.5	C1	B1	10
1	TRPA2525	<b>PROFILE SMALL WING 25/13/B1C1 5M*</b>	5010	24.8	13.0	13.5	17.3	18.8	12.5	C1	B1	10

\*Note: Available on request

### Fitting covers

Clear

**COVER SMALL C 16.4/4/C1**  
ZTPA2581, ZTPA2582,  
ZTPA2583\*

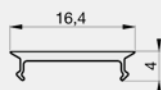

Frosted

**COVER SMALL F 16.4/4/C1**  
ZTPA2571, ZTPA2572,  
ZTPA2573\*

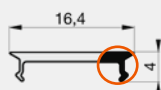

### Fitting end caps

Plastic

**ENDCAP PROFILE SMALL WING**  
ZTPA2612



### Fitting mounting accessories

Plastic mounting bracket

**BRACKET PROFILE SMALL PLT B1**  
ZTPA2620



Metal mounting bracket

**BRACKET PROFILE SMALL MET B1**  
ZTPA2621



Spring mounting bracket

**BRACKET SPRING SMALL B1**  
ZTPA2624



For details on profile accessories, refer to [page 75 ff.](#)

\*Info: The product is available in three standard lengths (1 m, 2 m, 3 m). The last digit of the article number represents the length in meters. Special lengths on request.



## Attachment Profile MEDIUM U

### Product features:

- High quality anodized aluminum profile with almost rimless light emission surface
- Optimal cooling and protection for up to two LED Strips
- Versatile installation options
- Simple and timeless design
- Internal, invisible mounting brackets



### Mounting:

- Installation with mounting brackets
- Installation by screwing
- Wire suspension



article no.



article no.



article no.

### Available lengths

#### Profiles

	1 m	2 m	3 m
	article no.	article no.	article no.
1 PROFILE MEDIUM U 27/25.9/B2C2	TRPA2541	TRPA2542	TRPA2543
2 PROFILE M U 27/25.9/B2C2 WHITE	-	TRPA4216	-
3 PROFILE M U 27/25.9/B2C2 BLACK	-	TRPA4217	-

#### Covers

COVER MEDIUM F 26/5/C2*	ZTPA2591	ZTPA2592	ZTPA2593
COVER MEDIUM SQUARE 27/14 C2	ZTPA3121	ZTPA3122	ZTPA3123
COVER MEDIUM BLACK 26/5 C2	-	ZTPA4482	-
COVER MEDIUM PRISMA 26/5 C2	-	ZTPA4492	ZTPA4493

\*Info: Also available in 20 m length, see [page 75](#).



1



2



3

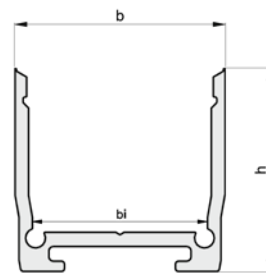

## PROFILE MEDIUM U

l (mm)

b (mm)

h (mm)

bi (mm)

pcs.



1	TRPA2541	<b>PROFILE MEDIUM U 27/25.9/B2C2 1M</b>	1010	27.0	25.9	22.2	C2	B2	4
1	TRPA2542	<b>PROFILE MEDIUM U 27/25.9/B2C2 2M</b>	2010	27.0	25.9	22.2	C2	B2	4
2	TRPA4216	<b>PROFILE M U 27/25.9/B2C2 2M WHITE</b>	2010	27.0	25.9	22.2	C2	B2	4
3	TRPA4217	<b>PROFILE M U 27/25.9/B2C2 2M BLACK</b>	2010	27.0	25.9	22.2	C2	B2	4
1	TRPA2543	<b>PROFILE MEDIUM U 27/25.9/B2C2 3M</b>	3010	27.0	25.9	22.2	C2	B2	4
1	TRPA2545	<b>PROFILE MEDIUM U 27/25.9/B2C2 5M*</b>	5010	27.0	25.9	22.2	C2	B2	4

\*Note: Available on request

### Fitting covers

Frosted

**COVER MEDIUM F 26/5/C2**  
ZTPA2591, ZTPA2592,  
ZTPA2593\*

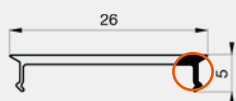

Frosted

**COVER MEDIUM SQUARE 27/14 C2**  
ZTPA3121, ZTPA3122,  
ZTPA3123\*

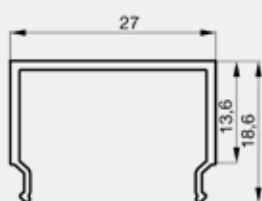

### Fitting end caps

Plastic

**ENDCAP PROFILE MEDIUM U**  
ZTPA2614



Plastic

**ENDCAP SQUARE PROFILE MEDIUM U**  
ZTPA3193



### Fitting mounting accessories

Plastic mounting bracket

**BRACKET PROFILE MEDIUM PLT B2**  
ZTPA2622



Metal mounting bracket

**BRACKET PROFILE MEDIUM MET B2**  
ZTPA2623



Wire suspension

**SUSPENSION KIT PROFILE M B2 2M**  
ZTPA3020



Wire suspension live

**SUSPENSION KIT POWER PROFILE M B2 2M**  
ZTPA3022



For details on profile accessories, refer to [page 75 ff.](#)

\*Info: The product is available in three standard lengths (1 m, 2 m, 3 m). The last digit of the article number represents the length in meters. Special lengths on request.

## Attachment Profile MEDIUM U FLAT

### Product features:

- High quality anodized aluminum profile with almost rimless light emission surface
- Optimal cooling and protection for up to two LED Strips
- Versatile installation options
- Simple and timeless design
- Internal, invisible mounting brackets



### Mounting:

- Installation with mounting brackets
- Installation by screwing
- Wire suspension



article no.



article no.



article no.

### Available lengths

#### Profiles

	1 m	2 m	3 m
	article no.	article no.	article no.
1 PROFILE MEDIUM U FLAT 27/10.2/B2C2	TRPA2551	TRPA2552	TRPA2553
2 PROFILE M U FLAT 27/10.2/B2C2 WHITE	-	TRPA4218	-
3 PROFILE M U FLAT 27/10.2/B2C2 BLACK	-	TRPA4219	-

#### Covers

COVER MEDIUM F 26/5/C2*	ZTPA2591	ZTPA2592	ZTPA2593
COVER MEDIUM SQUARE 27/14 C2	ZTPA3121	ZTPA3122	ZTPA3123
COVER MEDIUM BLACK 26/5 C2	-	ZTPA4482	-
COVER MEDIUM PRISMA 26/5 C2	-	ZTPA4492	ZTPA4493

\*Info: Also available in 20 m length, see [page 75](#).



1



2



3

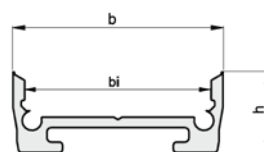

## PROFILE MEDIUM U FLAT

l (mm)

b (mm)

h (mm)

bi (mm)

pcs.



1	TRPA2551	PROFILE MEDIUM U FLAT 27/10.2/B2C2 1M	1010	27.0	10.2	22.2	C2	B2	6
1	TRPA2552	PROFILE MEDIUM U FLAT 27/10.2/B2C2 2M	2010	27.0	10.2	22.2	C2	B2	6
2	TRPA4218	PROFILE M U FLAT 27/10.2/B2C2 2M WHITE	2010	27.0	10.2	22.2	C2	B2	6
3	TRPA4219	PROFILE M U FLAT 27/10.2/B2C2 2M BLACK	2010	27.0	10.2	22.2	C2	B2	6
1	TRPA2553	PROFILE MEDIUM U FLAT 27/10.2/B2C2 3M	3010	27.0	10.2	22.2	C2	B2	6
1	TRPA2555	PROFILE MEDIUM U FLAT 27/10.2/B2C2 5M*	5010	27.0	10.2	22.2	C2	B2	6

\*Note: Available on request

### Fitting covers

Frosted

**COVER MEDIUM F 26/5/C2**  
ZTPA2591, ZTPA2592,  
ZTPA2593\*

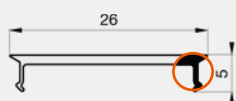

Frosted

**COVER MEDIUM SQUARE 27/14 C2**  
ZTPA3121, ZTPA3122,  
ZTPA3123\*

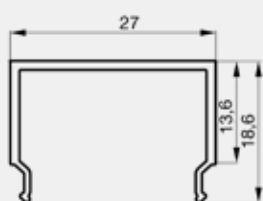

### Fitting end caps

Plastic

**ENDCAP PROFILE MEDIUM U FLAT**  
ZTPA2615



Plastic

**ENDCAP SQUARE PROFILE MEDIUM U FLAT**  
ZTPA3193



### Fitting mounting accessories

Plastic mounting bracket

**BRACKET PROFILE MEDIUM PLT B2**  
ZTPA2622



Metal mounting bracket

**BRACKET PROFILE MEDIUM MET B2**  
ZTPA2623



Wire suspension

**SUSPENSION KIT PROFILE M B2 2M**  
ZTPA3020



Wire suspension live

**SUSPENSION KIT POWER PROFILE M B2 2M**  
ZTPA3022



For details on profile accessories, refer to [page 75 ff.](#)

\*Info: The product is available in three standard lengths (1 m, 2 m, 3 m). The last digit of the article number represents the length in meters. Special lengths on request.

## Installation Profile MEDIUM WING

### Product features:

- High quality anodized aluminum profile
- Optimal cooling and protection for up to two LED Strips
- Optimized for installation e.g. in suspended ceilings and furniture
- Simple and timeless design



### Mounting:

- Installation with mounting brackets
- Installation by screwing
- Installation by clamping and glueing



article no.



article no.



article no.

### Available lengths

#### Profiles

	1 m	2 m	3 m
1 PROFILE MEDIUM WING 40/25.9/B2C2	TRPA2561	TRPA2562	TRPA2563
2 PROFILE M WING 40/25.9/B2C2 WHITE	-	TRPA4220	-
3 PROFILE M WING 40/25.9/B2C2 BLACK	-	TRPA4221	-

#### Covers

	1 m	2 m	3 m
COVER MEDIUM F 26/5/C2*	ZTPA2591	ZTPA2592	ZTPA2593
COVER MEDIUM BLACK 26/5 C2	-	ZTPA4482	-
COVER MEDIUM PRISMA 26/5 C2	-	ZTPA4492	ZTPA4493

\*Info: Also available in 20 m length, see [page 75](#).



1



2



3

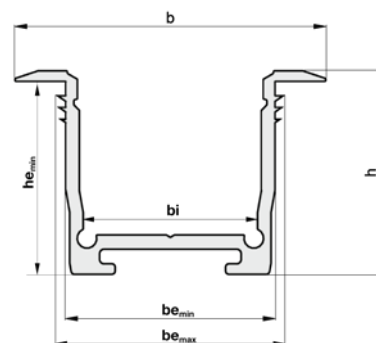

## PROFILE MEDIUM WING

l (mm)   b (mm)   h (mm)   bi (mm)   be<sub>min</sub> (mm)   be<sub>max</sub> (mm)   he<sub>min</sub> (mm)   pcs.



1	TRPA2561	<b>PROFILE MEDIUM WING 40/25.9/B2C2 1M</b>	1010	40.0	25.9	22.2	27.0	28.0	24.4	C2	B2	4
1	TRPA2562	<b>PROFILE MEDIUM WING 40/25.9/B2C2 2M</b>	2010	40.0	25.9	22.2	27.0	28.0	24.4	C2	B2	4
2	TRPA4220	<b>PROFILE M WING 40/25.9/B2C2 2M WHITE</b>	2010	40.0	25.9	22.2	27.0	28.0	24.4	C2	B2	4
3	TRPA4221	<b>PROFILE M WING 40/25.9/B2C2 2M BLACK</b>	2010	40.0	25.9	22.2	27.0	28.0	24.4	C2	B2	4
1	TRPA2563	<b>PROFILE MEDIUM WING 40/25.9/B2C2 3M</b>	3010	40.0	25.9	22.2	27.0	28.0	24.4	C2	B2	4
1	TRPA2565	<b>PROFILE MEDIUM WING 40/25.9/B2C2 5M*</b>	5010	40.0	25.9	22.2	27.0	28.0	24.4	C2	B2	4

\*Note: Available on request

### Fitting covers

Frosted

**COVER MEDIUM F 26/5/C2**  
ZTPA2591, ZTPA2592,  
ZTPA2593\*

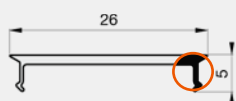

Prism optic

**COVER MEDIUM PRISMA 26/5 C2**  
ZTPA4492, ZTPA4493

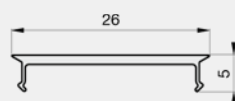

### Fitting end caps

Plastic

**ENDCAP PROFILE MEDIUM WING**  
ZTPA2616



### Fitting mounting accessories

Plastic mounting bracket

**BRACKET PROFILE MEDIUM PLT B2**  
ZTPA2622



Metal mounting bracket

**BRACKET PROFILE MEDIUM MET B2**  
ZTPA2623



Spring mounting bracket

**BRACKET SPRING MEDIUM B2**  
ZTPA2625



For details on profile accessories, refer to [page 75 ff.](#)

\*Info: The product is available in three standard lengths (1 m, 2 m, 3 m). The last digit of the article number represents the length in meters. Special lengths on request.

## Accessories for Aluminum Profiles



### Mounting brackets

		l (mm)	w (mm)	h (mm)			pcs.	
1	ZTPA2621	<b>BRACKET PROFILE SMALL MET B1</b>	20.0	18.5	8.0	B1	Metall	10
2	ZTPA2620	<b>BRACKET PROFILE SMALL PLT B1</b>	34.0	20.0	10.0	B1	Plastic	10
2	ZTPA4434	<b>BRACKET PROFILE SMALL PLT B1 WHITE</b>	34.0	20.0	10.0	B1	Plastic	10
2	ZTPA4433	<b>BRACKET PROFILE SMALL PLT B1 BLACK</b>	34.0	20.0	10.0	B1	Plastic	10
3	ZTPA2624	<b>BRACKET SPRING SMALL B1</b>	28.0	55.0	32.0	B1	Plastic	10
4	ZTPA2623	<b>BRACKET PROFILE MEDIUM MET B2</b>	20.0	15.0	5.9	B2	Metall	10
5	ZTPA2622	<b>BRACKET PROFILE MEDIUM PLT B2</b>	30.0	16.0	5.7	B2	Plastic	10
6	ZTPA2625	<b>BRACKET SPRING MEDIUM B2</b>	28.0	50.0	50.0	B2	Plastic	10



1

2

3

4



### Universal wire suspension

		l (m)	pcs.	
1	ZTPA4576	<b>SUSPENSION KIT PROFILE SMALL 2M 2PCS</b>	2	1
2	ZTPA3020	<b>SUSPENSION KIT PROFILE M B2 2M</b>	2	1
3	ZTPA3021	<b>SUSPENSION KIT POWER PROFILE S B1 2M</b>	2	1
4	ZTPA3022	<b>SUSPENSION KIT POWER PROFILE M B2 2M</b>	2	1

**Note:** One kit contains two suspension ropes. The POWER version enables the power supply through the ropes.





### Profile covers

		l (mm)	w (mm)	h (mm)		pcs.
1	ZTPA2581 <b>COVER SMALL C 16.4/4/C1 1M</b>	1010	16.4	4.0	○	10
2	ZTPA2571 <b>COVER SMALL F 16.4/4/C1 1M</b>	1010	16.4	4.0	○	10
2	ZTPA4472 <b>COVER SMALL BLACK 16.4/4 C1 2M</b>	2010	16.4	4.0	●	10
3	ZTPA3111 <b>COVER SMALL SQUARE 17/9 C1 1M</b>	1010	17.3	12.6	○	18
4	ZTPA2591 <b>COVER MEDIUM F 26/5/C2 1M</b>	1010	26.0	5.0	○	10
4	ZTPA4482 <b>COVER MEDIUM BLACK 26/5 C2 2M</b>	2010	26.0	5.0	●	10
5	ZTPA3121 <b>COVER MEDIUM SQUARE 27/14 C2 1M</b>	1010	27.0	18.6	○	8
6	ZTPA4492 <b>COVER MEDIUM PRISMA 26/5 C2 2M</b>	2010	26.0	5.0	○	10

### Available lengths profile covers



	Article no.	Article no.	Article no.	Article no.
1	<b>COVER SMALL C 16.4/4/C1</b>	ZTPA2581	ZTPA2582	ZTPA2583
2	<b>COVER SMALL F 16.4/4/C1</b>	ZTPA2571	ZTPA2572	ZTPA2573
2	<b>COVER SMALL BLACK 16.4/4 C1</b>	-	ZTPA4472	-
3	<b>COVER SMALL SQUARE 17/9 C1</b>	ZTPA3111	ZTPA3112	ZTPA3113
4	<b>COVER MEDIUM F 26/5/C2</b>	ZTPA2591	ZTPA2592	ZTPA2593
4	<b>COVER MEDIUM BLACK 26/5/C2</b>	-	ZTPA4482	-
5	<b>COVER MEDIUM SQUARE 27/14 C2</b>	ZTPA3121	ZTPA3122	ZTPA3123
6	<b>COVER MEDIUM PRISMA 26/5 C2</b>	-	ZTPA4492	ZTPA4493

## Accessories for Aluminum Profiles

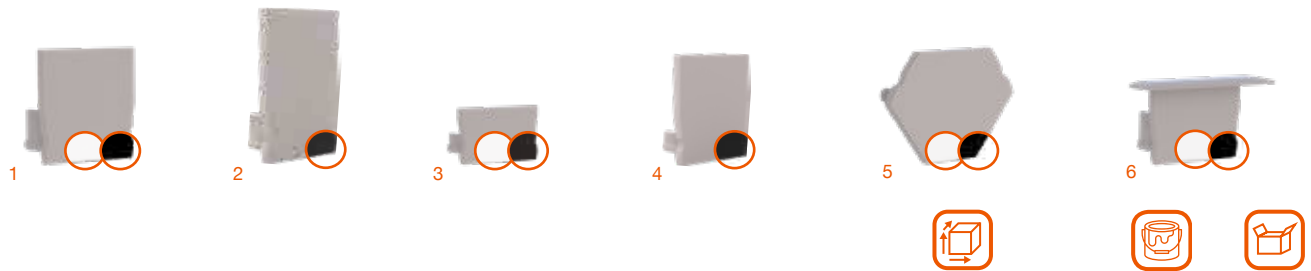

### End caps for profiles SMALL

		l (mm)	w (mm)	h (mm)		pcs.
1	ZTPA2610 <b>ENDCAP PROFILE SMALL U</b>	6.0	17.3	16.0	●	10
1	ZTPA4401 <b>ENDCAP PROFILE SMALL U WHITE</b>	6.0	17.3	16.0	○	10
1	ZTPA4400 <b>ENDCAP PROFILE SMALL U BLACK</b>	6.0	17.3	16.0	●	10
2	ZTPA3190 <b>ENDCAP SQUARE PROFILE S U GREY</b>	6.3	17.3	24.7	●	10
2	ZTPA3194 <b>ENDCAP SQUARE PROFILE S U BLACK</b>	6.3	17.3	24.7	●	10
3	ZTPA2611 <b>ENDCAP PROFILE SMALL U FLAT</b>	6.0	17.3	9.6	●	10
3	ZTPA4406 <b>ENDCAP PROFILE SMALL U FLAT WHITE</b>	6.0	17.3	9.6	○	10
3	ZTPA4405 <b>ENDCAP PROFILE SMALL U FLAT BLACK</b>	6.0	17.3	9.6	●	10
4	ZTPA3191 <b>ENDCAP SQUARE PROFILE S U FLAT GREY</b>	6.3	17.3	18.3	●	10
4	ZTPA3195 <b>ENDCAP SQUARE PROFILE S U FLAT BLACK</b>	6.3	17.3	18.3	●	10
5	ZTPA2613 <b>ENDCAP PROFILE SMALL CORNER</b>	6.0	20.9	20.9	●	10
5	ZTPA4413 <b>ENDCAP PROFILE SMALL CORNER WHITE</b>	6.0	20.9	20.9	○	10
5	ZTPA4412 <b>ENDCAP PROFILE SMALL CORNER BLACK</b>	6.0	20.9	20.9	●	10
6	ZTPA2612 <b>ENDCAP PROFILE SMALL WING</b>	6.0	24.9	13.0	●	10
6	ZTPA4411 <b>ENDCAP PROFILE SMALL WING WHITE</b>	6.0	24.9	13.0	○	10
6	ZTPA4410 <b>ENDCAP PROFILE SMALL WING BLACK</b>	6.0	24.9	13.0	●	10

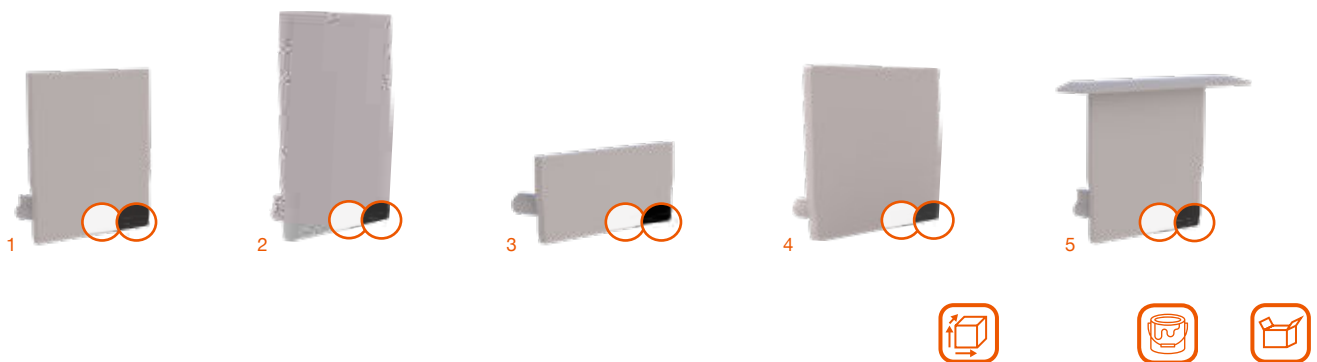





### End caps for profiles MEDIUM

		l (mm)	w (mm)	h (mm)		pcs.
1	ZTPA2614 <b>ENDCAP PROFILE MEDIUM U</b>	6.0	27.0	25.9	●	10
1	ZTPA4960 <b>ENDCAP PROFILE MEDIUM U WHITE</b>	6.0	27.0	25.9	○	10
1	ZTPA2617 <b>ENDCAP PROFILE MEDIUM U BLACK</b>	6.0	27.0	25.9	●	10
2	ZTPA3192 <b>ENDCAP SQUARE PROFILE M U GREY</b>	6.5	27.0	39.0	●	10
2	ZTPA4963 <b>ENDCAP SQUARE PROFILE M U WHITE</b>	6.5	27.0	39.0	○	10
2	ZTPA3196 <b>ENDCAP SQUARE PROFILE M U BLACK</b>	6.5	27.0	39.0	●	10
3	ZTPA2615 <b>ENDCAP PROFILE MEDIUM U FLAT</b>	6.0	27.0	10.2	●	10
3	ZTPA4961 <b>ENDCAP PROFILE MEDIUM U FLAT WHITE</b>	6.0	27.0	10.2	○	10
3	ZTPA2618 <b>ENDCAP PROFILE MEDIUM U FLAT BLACK</b>	6.0	27.0	10.2	●	10
4	ZTPA3193 <b>ENDCAP SQUARE PROFILE M U FLAT GREY</b>	6.5	27.0	23.8	●	10
4	ZTPA4964 <b>ENDCAP SQUARE PROFILE M U FLAT WHITE</b>	6.5	27.0	23.8	○	10
4	ZTPA3197 <b>ENDCAP SQUARE PROFILE M U FLAT BLACK</b>	6.5	27.0	23.8	●	10
5	ZTPA2616 <b>ENDCAP PROFILE MEDIUM WING</b>	6.0	40.0	25.9	●	10
5	ZTPA4962 <b>ENDCAP PROFILE MEDIUM WING WHITE</b>	6.0	40.0	25.9	○	10
5	ZTPA2619 <b>ENDCAP PROFILE MEDIUM WING BLACK</b>	6.0	40.0	25.9	●	10













# Compatibility of Accessories SMALL

Product family		PROFILE SMALL U	PROFILE SMALL U FLAT	PROFILE SMALL CORNER	PROFILE SMALL WING
Page		60	62	64	66
<b>BRACKET PROFILE SMALL MET B1</b> ZTPA2621		x	x	x	x
<b>BRACKET PROFILE SMALL PLT B1</b> ZTPA2620 (grey) / ZTPA4434 (white) / ZTPA4433 (black)		x	x	x	x
<b>BRACKET SPRING SMALL B1</b> ZTPA2624					x
<b>ENDCAP PROFILE SMALL U</b> ZTPA2610 (grey) / ZTPA4401 (white) / ZTPA2717 (black)		x			
<b>ENDCAP PROFILE SMALL U FLAT</b> ZTPA2611 (grey) / ZTPA4406 (white) / ZTPA2718 (black)			x		
<b>ENDCAP PROFILE SMALL CORNER</b> ZTPA2613 (grey) / ZTPA4413 (white) / ZTPA2720 (black)				x	
<b>ENDCAP PROFILE SMALL WING</b> ZTPA2612 (grey) / ZTPA4411 (white) / ZTPA2719 (black)					x
<b>ENDCAP SQUARE PROFILE SMALL U</b> ZTPA3190 (grey) / ZTPA3194 (black)		x*			
<b>ENDCAP SQUARE PROFILE SMALL U FLAT</b> ZTPA3191 (grey) / ZTPA3195 (black)			x*		
<b>SUSPENSION KIT PROFILE SMALL</b> <b>2M 2PCS</b> ZTPA4576		x	x	x	
<b>SUSPENSION KIT POWER PROFILE S B1 2M</b> ZTPA3021		x	x	x	

\*Note: In combination with COVER SMALL SQUARE 17/9 C1

# Compatibility of Accessories MEDIUM

Product family		PROFILE MEDIUM U	PROFILE MEDIUM U FLAT	PROFILE MEDIUM WING
Page		68	70	72
<b>BRACKET PROFILE MEDIUM MET B2</b> ZTPA2623		x	x	x
<b>BRACKET PROFILE MEDIUM PLT B2</b> ZTPA2622		x	x	x
<b>BRACKET SPRING MEDIUM B2</b> ZTPA2625				x
<b>ENDCAP PROFILE MEDIUM U</b> ZTPA2614 (grey) / ZTPA4960 (white) / ZTPA2617 (black)		x		
<b>ENDCAP PROFILE MEDIUM U FLAT</b> ZTPA2615 (grey) / ZTPA4961 (white) / ZTPA2618 (black)			x	
<b>ENDCAP PROFILE MEDIUM WING</b> ZTPA2616 (grey) / ZTPA4962 (white) / ZTPA2619 (black)				x
<b>ENDCAP SQUARE PROFILE MEDIUM U</b> ZTPA3192 (grey) / ZTPA4963 (white) / ZTPA3196 (black)		x*		
<b>ENDCAP SQUARE PROFILE MEDIUM U FLAT</b> ZTPA3193 (grey) / ZTPA4964 (white) / ZTPA3197 (black)			x*	
<b>SUSPENSION KIT PROFILE M B2 2M</b> ZTPA3020		x	x	
<b>SUSPENSION KIT POWER PROFILE M B2 2M</b> ZTPA3022		x	x	

\*Note: In combination with COVER MEDIUM SQUARE 27/14 C2



# Products.

## Power Supply.

With the control gears offered by Radium you will find the right solution for every requirement indoors and outdoors. The energy-efficient, powerful and durable devices are designed for the operation of LED modules with constant voltage DC and they are easy to install. In combination with our LED Strips, you can implement future-proof systems with high light quality and highest operational safety requirements.

### **Product features:**

- Optimized and approved for the operation of LEDs for lighting purposes
- Protection against excess voltage and high temperatures
- For indoor and outdoor applications: protection class up to IP67
- Fully integrable into many building automation systems





# Content

LED Drivers	82
LED Phasecut Drivers	83
Dimmable LED Drivers	84
LED Dimmers	86

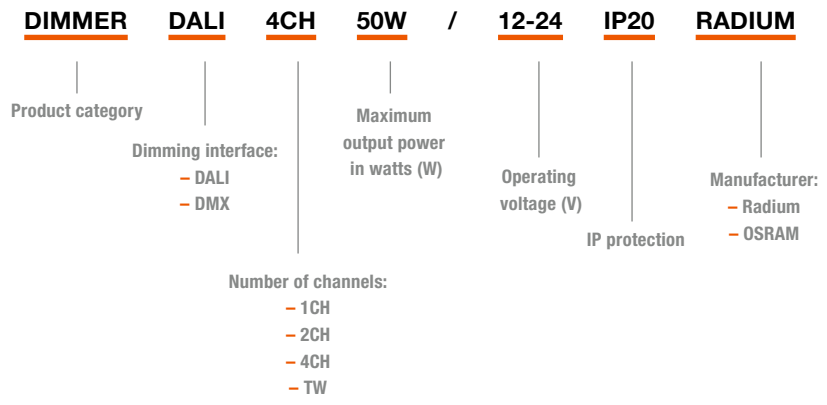
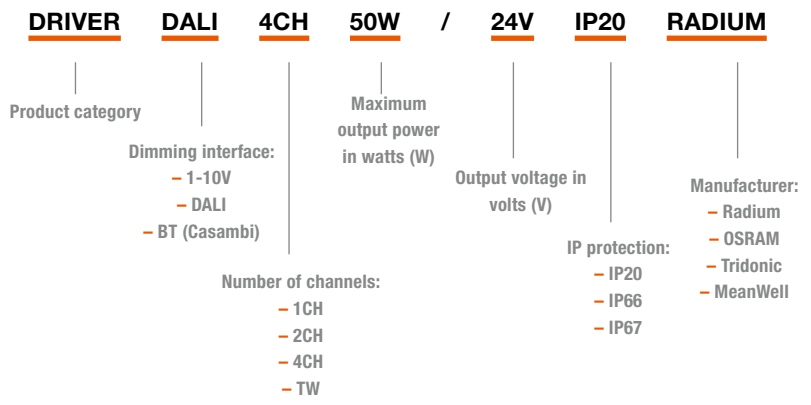



## LED Drivers

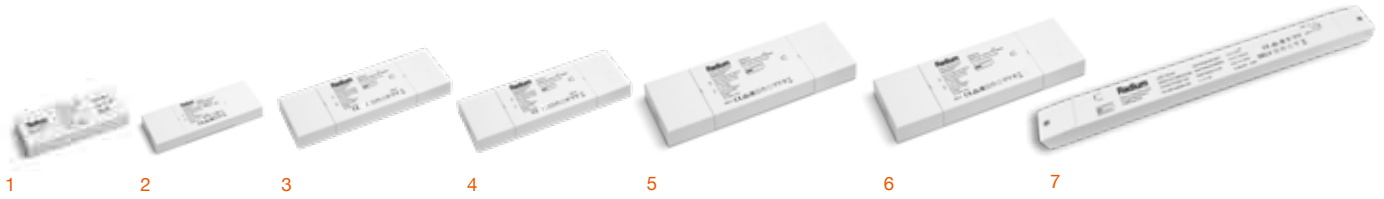

### LED Drivers Flat

V °C max. °C l (mm) w (mm) h (mm) h pcs.



24 DC 50/60

			V	°C	max. °C	l (mm)	w (mm)	h (mm)	h	pcs.
1	OTNA3100	DRIVER FLAT 12W/24V IP20 RADIUM	220...240	-25...+45	-25...+90	112	46	16	50000	115
2	OTNA3101	DRIVER FLAT 24W/24V IP20 RADIUM	220...240	-25...+45	-25...+90	137	50	16	50000	95
3	OTNA3102	DRIVER FLAT 36W/24V IP20 RADIUM	220...240	-25...+45	-25...+90	170	57	18	50000	65
4	OTNA3103	DRIVER FLAT 60W/24V IP20 RADIUM	220...240	-25...+45	-25...+90	170	57	18	50000	65
5	OTNA3104	DRIVER FLAT 90W/24V IP20 RADIUM	220...240	-25...+45	-25...+90	190	65	22	50000	40
6	OTNA3105	DRIVER FLAT 120W/24V IP20 RADIUM	220...240	-25...+45	-25...+90	190	65	22	50000	40
7	OTNA3106	DRIVER FLAT 250W/24V IP20 RADIUM	220...240	-25...+45	-25...+90	400	40	22	50000	40



### LED Drivers Waterproof

V °C max. °C l (mm) w (mm) h (mm) h pcs.



24 DC 50/60

			V	°C	max. °C	l (mm)	w (mm)	h (mm)	h	pcs.
1	OTNA1962	DRIVER 20W/24V IP66 OSRAM	220...240	-30...+55	70	178	43	25	50000	20
2	OTNA2420	DRIVER 40W/24V IP66 OSRAM	220...240	-30...+55	85	208	43	26	50000	20
3	OTNA2421	DRIVER 60W/24V IP66 OSRAM	220...240	-20...+55	80	208	43	26	50000	20
4	OTNA2450	DRIVER 75W/24V IP67 MeanWell	220...240	-30...+55	90	140	63	32	50000	24
5	OTNA2451	DRIVER 100W/24V IP67 MeanWell	220...240	-30...+55	90	140	63	32	50000	24
6	OTNA1960	DRIVER 100W/24V IP67 OSRAM	220...240	-30...+55	80	240	50	34	50000	10
7	OTNA2422	DRIVER 130W/24V IP67 OSRAM	220...240	-30...+55	80	220	63	37	50000	10
8	OTNA2452	DRIVER 150W/24V IP67 MeanWell	220...240	-30...+55	90	180	63	36	50000	16
9	OTNA2453	DRIVER 200W/24V IP67 MeanWell	220...240	-30...+55	90	199	63	36	50000	16
10	OTNA1961	DRIVER 250W/24V IP67 OSRAM	220...240	-30...+55	85	265	68	40	50000	10

# LED Phasecut Drivers



1



2



3



## Dimmable LED Drivers, Phasecut Dimmers

°C    max. °C    l (mm)    w (mm)    h (mm)    h    pcs.



220-240    50/60    24 DC

One-Channel

1	OTDA4077	<b>DRIVER PHASECUT 36W/24V IP20 RADIUM</b>	1	-20...+50	-20...+90	210	43	30	50000	50
2	OTDA3026	<b>DRIVER PHASECUT 75W/24V IP20 RADIUM</b>	1	-30...+55	-30...+70	293	43	30	50000	40
3	OTDA4078	<b>DRIVER PHASECUT 150W/24V IP20 RADIUM</b>	1	-20...+50	-20...+85	352	43	30	50000	20

### Product features:

- Dimmable with conventional leading and trailing edge dimmers
- Very high compatibility with various dimmer models
- FlickerFree acc. to IEEE 1789 Standard
- Touch & DIM-interface (Dimming by wall switch without any additional accessories)
- Safety thanks to overload protection, overtemperature protection, overvoltage protection and short-circuit protection



Perfectly combinable with **LED Strip WarmDIM**:  
Dim and adjust colour temperature without additional control!  
More information on [page 30](#).

### Wiring diagram Radium Phasecut Driver in combination with LED Strip WarmDIM

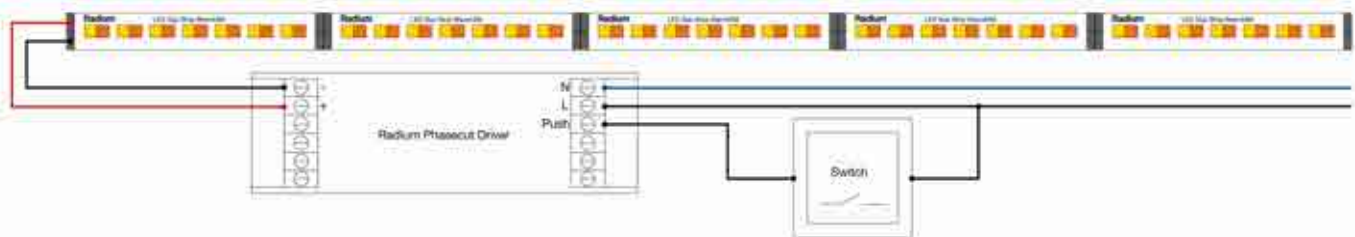

## Dimmable LED Drivers



1

2

3

4

5

6

7



### Dimmable LED Drivers, DALI

°C max. °C l (mm) w (mm) h (mm) h pcs.



220-240 50/60 24 DC

1	OTDA4070	<b>DRIVER DALI 1CH 36W/24V IP20</b>	1	-25...+50	90	210	43	30	50000	40
2	OTDA4071	<b>DRIVER DALI 1CH 75W/24V IP20</b>	1	-25...+50	80	293	43	30	50000	30
3	OTDA4072	<b>DRIVER DALI 1CH 100W/24V IP20</b>	1	-25...+50	80	293	43	30	50000	30
4	OTDA4073	<b>DRIVER DALI 1CH 150W/24V IP20</b>	1	-25...+50	85	352	43	30	50000	20
5	OTDA4074	<b>DRIVER DALI 2CH 75W/24V IP20</b>	2	-25...+50	80	293	43	30	50000	30
6	OTDA4075	<b>DRIVER DALI 2CH 150W/24V IP20</b>	2	-25...+50	85	352	43	30	50000	20
7	OTDA4076	<b>DRIVER DALI/DMX 4CH 150W/24V IP20</b>	4	-25...+50	85	352	43	30	50000	20



1

2



### Dimmable LED Drivers Waterproof, DALI

°C max. °C l (mm) w (mm) h (mm) h pcs.



50/60 24 DC

1	OTDA4107	<b>DRIVER DALI 1-4CH 100W/24V IP67 OSRAM</b>	1-4	-30...+55	85	237	69	30	50000	6
2	OTDA2461	<b>DRIVER DALI 4CH 210W/24V IP67 OSRAM</b>	1-4	-30...+55	85	330	69	37	50000	6

## Dimmable LED Drivers



### Dimmable LED Drivers Waterproof, 1-10V

V °C max. °C l (mm) w (mm) h (mm) h pcs.



24 DC 50/60

1	OTDA2424	DRIVER 1-10V 20W/24V IP66 OSRAM	220...240	-30...+55	85	178	43	25	50000	20
3	OTDA2426	DRIVER 1-10V 60W/24V IP66 OSRAM	220...240	-30...+50	90	208	43	26	50000	20
4	OTDA2427	DRIVER 1-10V 100W/24V IP67 OSRAM	220...240	-30...+55	80	240	50	34	50000	10
5	OTDA2428	DRIVER 1-10V 130W/24V IP67 OSRAM	220...240	-30...+55	80	220	63	37	50000	10
6	OTDA2429	DRIVER 1-10V 250W/24V IP67 OSRAM	220...240	-30...+55	85	265	68	40	50000	10



°C max. °C l (mm) w (mm) h (mm) h pcs.



220...240 50/60 24 DC

1	OTDA2443	DRIVER BT 1CH 35W/24V IP20 TRIDONIC	1	-25...+50	80	195	43	30	50000	10
2	OTDA2444	DRIVER BT 1CH 60W/24V IP20 TRIDONIC	1	-25...+50	75	225	43	30	50000	10
3	OTDA2445	DRIVER BT 1CH 100W/24V IP20 TRIDONIC	1	-25...+50	75	295	43	30	50000	10
4	OTDA2446	DRIVER BT 1CH 150W/24V IP20 TRIDONIC	1	-25...+50	90	325	43	30	50000	10

## LED Dimmers



1

### Smart LED Dimmer, Casambi



W °C max. °C l (mm) w (mm) h (mm) pcs.



12...24 DC 4

	W	°C	max. °C	l (mm)	w (mm)	h (mm)	pcs.
1 LMBA4969 CBU-PWM4-LR	144	-20...+45	75	73	30	18	1

#### Product features:

- Control of 1-4 channels
- Voltage range: 12-24V DC
- Flexible use thanks to compact design
- Ideal for RGB, RGBW and tunable white applications
- Compatible with all other Casambi devices
- Up to 100 m reception range thanks to LongRange (LR) Bluetooth technology



1

### LED Dimmer, Zigbee



W °C max. °C l (mm) w (mm) h (mm) max. per Channel pcs.



12...24 5

	W	°C	max. °C	l (mm)	w (mm)	h (mm)	max. per Channel	pcs.
1 LMZA4000 DIMMER ZIGBEE 5CH 480W/12-24V IP20	480	-20...+45	75	145	46	16	4	1

#### Product features:

- Powerful 4-in-1 Zigbee dimmer for RGB, RGBW, TW and white LED strips
- Dimmable up to 4A or 96W LED strips per channel
- For integration into smart home systems
- Control with the most popular voice controls like Alexa and Google
- Zigbee certified product

# LED Dimmers



## LED Dimmers, RF



-20...+45°C    max. 75°C    50,000 h

	W	V	CH	l (mm)	w (mm)	h (mm)	max. per Channel	pcs.
1 LMRA3970 <b>DIMMER RF 1CH 240W/12-24V IP20</b>	240*	12...24	1	145	46	16	10	1
2 LMRA3971 <b>DIMMER RF 4CH 480W/12-36V IP20</b>	480*	12...36	4	176	46	18	5	1

\*Note: With 24V input voltage

### Dimmer RF 1CH:

- For dimming of single colour white LED strips up to 240W power (at 24V)
- Flat, compact design

### Dimmer RF 4CH:

- RF dimmer for RGB, RGBW and white LED strips up to 5A or 120W power per channel (at 24V)

Our RF dimmers can be conveniently controlled by **Remote control**. You will find these on [page 93](#).

- Easy to connect (also several remote controls with one dimmer or one remote control with several dimmers possible)
- Fast response time
- Wide range thanks to RF technology



# Products. **Control Units.**



With the increasing demands in the course of digitization, our control units offer even more possibilities to you. They are easy to install, can be adjusted flexibly and operated intuitively. In combination with intelligent sensors and the use of daylight, you achieve maximum energy savings and use light in a targeted and needs-based manner. Make use of all of these options with Radium!







# Content

Smart Lighting Control	90
InProfile Sensors	92
Accessories	93
Compatibility of Accessories	93

# Smart Lighting Control

## Product features:

- Can be combined with luminaires or control gears with suitable interfaces (1-10V or DALI)
- Setup of a conventional push button for control possible
- Colour control for DALI RGB or colour temperature control for tunable white light sources
- Compatible with all other Casambi devices
- Easy control via smartphone or tablet using the Casambi app
- Up to 100 m reception range thanks to LongRange (LR) Bluetooth technology



1



## Casambi Control Unit



220...240 50/60

DALI, 1-10V

			°C	max. °C	l (mm)	w (mm)	h (mm)	pcs.			
1	LMBA4952	<b>CBU-ASD-LR</b>	DALI	1	1	-20...+40	70	57	36	22	1



## Smart switch

### Product features:

- Switch and dim up to 4 groups or lamps, as well as recall scenes and animations
- Completely batteryless and wireless switch

**Bluetooth Control Wall Switch 1-2CH**  
LMZA1736

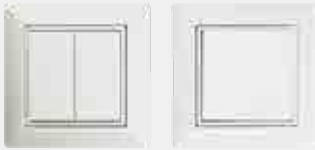

## Smart remote control

### Product features:

- Freely programmable by Casambi app
- Setting the colour temperature of tunable white light sources
- Can be used as a wall switch on the magnetic holder or as remote control
- Compatible with all other Casambi devices

**XPRESS-LR WHITE**  
LMZA4955



**XPRESS-LR BLACK**  
LMZA4954



## Dimmer for lamps

### Product features:

- Direct dimming of 230V lamps without additional components
- Very well compatible with dimmable LED lamps
- Up to 150W can be conveniently dimmed with a BCU-TED

**CBU-TED-LR**  
LMBA4953



## App

### One app – many intelligent functions

- Light sources are found by the app
- Combine luminaires in groups and control them
- Create light scenes with individual dimming and colour values, e.g. warm, bright, romantic...
- Timer function, e.g. Set alarm clock
- Mesh network: units communicate with each other, so that the Bluetooth range is expanded
- Scenes can be retrieved using the classic light switch
- Compatible with many iOS and Android devices (Bluetooth 4.0)

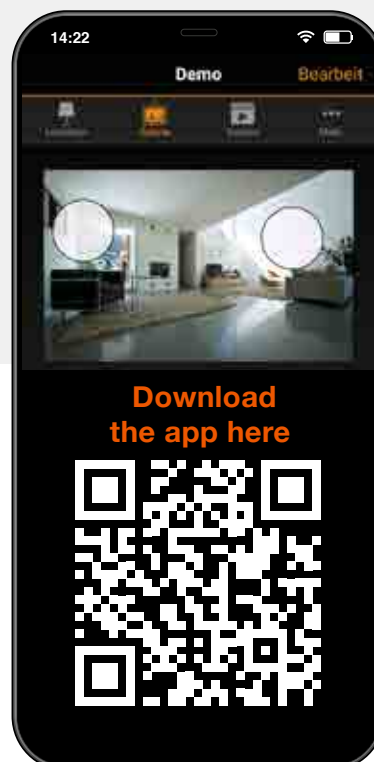

## InProfile Sensors



### Sensors



12-24 DC 12-24 DC

One-Channel

			A	W	°C Ta	l (mm)	w (mm)	h (mm)	pcs.
1	LMCA3030	<b>IN-PROFILE TOUCH&amp;DIM SENSOR 72W/12-24V</b>	3	72	-30...+55	50	8	10	30
2	LMCA3031	<b>IN-PROFILE MOTION SENSOR 72W/12-24V</b>	3	72	-30...+55	50	11	12	30
3	LMCA3032	<b>IN-PROFILE DOOR SENSOR 96W/12-24V</b>	4	96	-30...+55	50	11	8	30
4	LMCA3033	<b>IN-PROFILE WINK SENSOR 96W/12-24V</b>	4	96	-30...+55	50	11	9	30

### Product features:

- Versatile sensors, some with dimming function
- Compact design for installation in Radium aluminum profiles
- Easy dimming and switching of 12-24V LED strips
- Up to 96W per sensor/dimmer at 24V

### Functions

1	<b>IN-PROFILE TOUCH&amp;DIM SENSOR 72W/12-24V</b>	Dim light by tapping the profile cover
2	<b>IN-PROFILE MOTION SENSOR 72W/12-24V</b>	Switch on light by motion detection
3	<b>IN-PROFILE DOOR SENSOR 96W/12-24V</b>	Switch on light by opening the (cabinet) door thanks to optical door contact sensor
4	<b>IN-PROFILE WINK SENSOR 96W/12-24V</b>	Switching light by movement over the profile cover

## Accessories for Control Units



### Casambi Accessories

		l (mm)	w (mm)	h (mm)	pcs.
1	LMZA1736 <b>Bluetooth Control Wall Switch 1-2CH</b>	81	81	14	1
2	LMZA4955 <b>XPRESS-LR WHITE</b>	90	90	12	1
3	LMZA4954 <b>XPRESS-LR BLACK</b>	90	90	12	1



### RF Accessories

		l (mm)	w (mm)	h (mm)	pcs.
1	LMZA3972 <b>REMOTE RF WHITE 4Z</b>	150	39	11	1
2	LMZA3973 <b>REMOTE RF RGB 4Z</b>	120	55	17	1
3	LMZA3974 <b>REMOTE RF DOT 1Z WHITE</b>	32	32	12	1
4	LMZA3975 <b>REMOTE RF DOT 1Z BLACK</b>	32	32	12	1

## Compatibility of Accessories

Product family	DIMMER RF 1CH 240W/ 12-24V IP20	DIMMER RF 4CH 480W/ 12-36V IP20	Casambi Control Units, DALI
Page	87	87	90
<b>Bluetooth Control Wall Switch 1-2CH</b> LMZA1736 			x
<b>SMART Blue Remote</b> LMZA4955 (white) / LMZA4954 (black) 			x
<b>REMOTE RF WHITE 4Z</b> LMZA3972 	x		
<b>REMOTE RF RGB 4Z</b> LMZA3973 		x	
<b>REMOTE RF DOT 1Z</b> LMZA3974 (white) / LMZA3975 (black) 	x		

# Overview of Important Information.

## Technical Information.

### Electrical information

Radium LED Strips are suitable for operation with 24V DC voltage only. Suitable control gears can be found on [pages 80–87](#). Depending on the LED strip, one or two supply lines per module are pre-assembled at the factory. The cables of the supply lines can be extended on site.

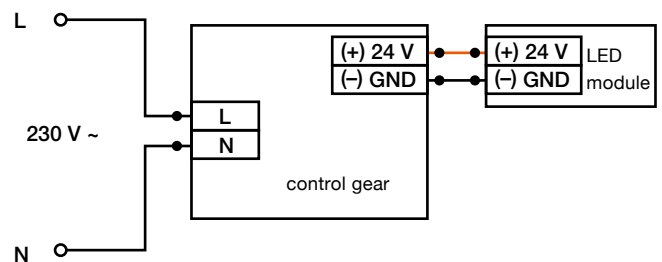

### Cable lengths

The LED strips must not be operated at any random distance from the control gear. The maximum cable lengths depend on the device and are published in the technical data sheets of the control gear. When long cable lengths and/or high currents occur, sufficiently large cable cross sections must be used.

### ESD protection

LED strips can be damaged by electrostatic discharge (ESD), up to a total failure of the LEDs. If the ESD damage is less serious, the LEDs remain conductive and light up, but darken quickly. To avoid ESD damage, LED strips must be stored in an ESD-protected environment and processed and assembled with appropriate protection. Therefore at our professional customising LED Strip assemblies we work in areas with special ESD protection exclusively.

### Assembly

All LED Strips are equipped with 3M double-sided adhesive tape. After removing the protective film, the LED module can be glued to clean and smooth surfaces. Optionally, the modules can be installed directly in suitable aluminum profiles (see [pages 58–73](#)). Make sure you have a clean surface that must be free of grease, oil, silicone and dirt particles.

## IP Protection

In order to protect our LED Strips from environmental influences, all waterproof Essence Strips are enveloped in a silicone tube and potted at both ends. Our waterproof Star Strips are encapsulated with silicone. IP protection indicates the suitability of electrical equipment for various environmental conditions.

### Degree of protection against dust and foreign bodies

- 0 Not protected
- 1 Protected against solid foreign bodies  $\emptyset$
- 2 Protected against solid foreign bodies  $\geq 12.5 \text{ mm } \emptyset$
- 3 Protected against solid foreign bodies  $\geq 2.5 \text{ mm } \emptyset$
- 4 Protected against solid foreign bodies  $\geq 1 \text{ mm } \emptyset$
- 5 Protected from dust
- 6 Dustproof

### Example: IP67

Dustproof, protected against temporary immersion in water

### Degree of protection against water

- 0 Not protected
- 1 Protected against dripping water
- 2 Protected against dripping water if the housing is inclined
- 3 Protected against water spray
- 4 Protected against splash water
- 5 Protected against water jets
- 6 Protected against strong water jets
- 7 Protected against temporary immersion in water
- 8 Protected against permanent immersion in water
- 9 Protection against water during high pressure/steam jet cleaning

## Cooling

All Radium LED Strips with a power of  $> 15 \text{ W/m}$  as well as all RGB strips must not be operated without heat sink. Radium aluminum profiles are recommended for optimal cooling (see [page 58–73](#)). If the modules are not operated with approved Radium accessories, Radium cannot accept any warranty claims.



### Maximum operable length

The specified maximum operable length of the LED Strips requires an input voltage of 24V at the LED Strip. If the voltage actually fed in is lower due to a too long supply line, the maximum operable length might be proportionately shorter.



### Guarantee

Radium LED products are known for high quality engineering, professional thermal management, the use of high quality components and the use of systematic quality assurance measures. For LED Strips that correspond to the product and application specifications given by Radium, e.g. data sheets, application notes or compatibility lists, Radium provides a guarantee up to 5 years. [www.radium.de/guarantee](http://www.radium.de/guarantee)



### Star

Optimal function for professional use.  
All Star types offer a longer service life and very good efficiency.

















### Essence

All Essence types offer pure functionality at the best price.



# The Meaning of the Symbols.

## Pictograms.

 Power consumption (W)	 Energy label
 Input voltage (V)	 Material
 Output voltage (V)	 Colour temperature <ul style="list-style-type: none"> <li><span style="color: #e67e22;">●</span> 2700/3000 K (warm white)</li> <li><span style="color: #34495e;">○</span> ~ 4000 K (neutral white)</li> <li><span style="color: #2980b9;">●</span> ~ 6500 K (cool white)</li> <li><span style="color: #e67e22;">●</span> super warm white–neutral white</li> <li><span style="color: #34495e;">●</span> warm white–cool white</li> <li><span style="color: #2980b9;">●</span> RGB/RGBW</li> </ul>
 Voltage (V)	
 Amperage (A)	
 Permissible ambient temperature (°C)	 Power consumption per meter (W/m)
 Permissible operating temperature (°C)	 Luminous flux per meter (lm/m)
 Mains frequency (Hz)	 LEDs per meter
 Dimensions length / width / height (mm)	 Smallest divisible unit of an LED Strip (mm)
 Lifetime (h)	 Maximum operable length for the LED Strip with one feed-in connection
 Protection class I	 5 meter reel of LED Strip
 Protection class II	 30 meter reel of LED Strip
 Protection class III	 50 meter reel of LED Strip
 Shipping unit in pieces (pcs.)	 Individual length for LED Strip (m)



Distance (pitch) from centre LED to centre LED (mm)



Number of contact points of an LED Strip



Width of LED Strip (mm)



Cable length (mm)



Interface profile to cover



Interface profile to mounting bracket



Profile shape U (add-on/attachment profile)



Profile shape U FLAT (add-on/attachment profile flat)



Profile shape WING (installation profile)



Profile shape CORNER (corner profile)



1 meter length for aluminum profiles and covers



2 meters length for aluminum profiles and covers



3 meters length for aluminum profiles and covers



20 meters length for covers



Size SMALL for aluminum profiles



Size MEDIUM for aluminum profiles



DIM interface



Number of channels of a control gear



For Multi-Channel:  
Max. number of addresses of a control gear  
For broadcast:  
Max. number of control gear



Number of poles/leads



Number of outputs



Cable cross section (mm<sup>2</sup>)



Color

**Radium Lampenwerk GmbH**

Dr.-Eugen-Kersting-Str. 6  
51688 Wipperfürth  
Germany

Telephone +49 (0) 2267 811  
Telefax +49 (0) 2267 81353

radium@radium.de  
**www.radium.de**