



Slim Panel Performer UGR19 G6







- Laadukas, ohut LED-paneelivalaisin, sopii toimistoihin (UGR19)
- Vakio IP54 (etupuoli)
- Upotettava, ripustettava ja pinta-asennus mahdollista



Tuotetiedot

Tuotekoodi	Tuotenimi	Vastaava hehku-lamppu	Teho (W)	Valovirta (lm)	Valotehokkuus (lm/W)	Valonväri (K)	CRI	Paino (kg/kpl)
542003114100	LEDPanelS-P6 Re295-34W-BLE2-940-U19	TL 2x36W	34	4080	120	4000	> 90	1,99

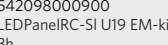
Varusteet

Surface Mounting Frame		Recessed Mounting Frame				
						
140055486 LEDPanelRc-SI Re300-Surface-Module-WH-CT	542098017700 LEDPanelRc2 Re300-Surface-Kit-WH	542098009800 LEDPanelRc Re300-Frame-WH	542098045500 LEDPanelS-P Suspension-Kit-G6	542098000800 LEDPanelRC-SI U19 EM-kit 1h	542098000900 LEDPanelRC-SI U19 EM-kit 3h	140060852 LEDFixture-Ceiling-Cable-Kit-0.5m
						
542098030700 Junction-Box-WH						

Pakkaustiedot

Tuote			Pakkaus			
Tuotekoodi	Tuotenimi	EU HS Code	Mitat (mm) (PxLxK)	Bruttopaino (kg)	EAN	kpl / laatikko
542003114100	LEDPanelS-P6 Re295-34W-BLE2-940-U19	94051190	1306x41x333	2,67	6941497774842	1
140055486	LEDPanelRc-SI Re300-Surface-Module-WH-CT	94059900	1290x390x118	4,60	6956321879822	1
140060852	LEDFixture-Ceiling-Cable-Kit-0.5m	73121020	100x100x5	0,40	6956321895266	1
542003021800	LEDPanelRc-S-B2 Mounting-Springs	73209090	280x200x170	0,10	6941408821672	1
542098000800	LEDPanelRC-SI U19 EM-kit 1h	85044083	490x390x150	0,98	6941497702340	1
542098000900	LEDPanelRC-SI U19 EM-kit 3h	85044083	490x390x150	1,08	6941497702333	1
542098009800	LEDPanelRc Re300-Frame-WH	94059900	388x90x1290	1,93	6941497704047	1
542098017700	LEDPanelRc2 Re300-Surface-Kit-WH	94059900	1394x77x68	1,95	6941497720672	1
542098030700	Junction-Box-WH	85369010	43x103.4x26	0,06	6941408868684	1
542098045500	LEDPanelS-P Suspension-Kit-G6	73121020	130x130x30	0,22	6941497784773	1
560098000600	LEDSmart-Sensor Surface-Module-WH	94059200	330x220x255	0,15	6941497703972	1
821006001800	LEDSmart-BLE2-Rc-MW-Sensor	85365005	100x100x130	0,19	6941497782777	1
821006002000	LEDSmart-BLE2-Rc-PIR-Sensor	85365005	100x100x70	0,19	694149778260	1
821009000200	LEDSmart-BLE2-Switch	85365005	89x21x101	0,10	694149778253	1
821011002600	LEDSmart-BLE2-DALI-Connect-Box	85176200	100x60x105	0,30	694149778291	1
821017003400	LEDSmart-BLE2-Multi-Switch-Module	94059200	46x46x30	0,07	6931783007600	1
821017003800	LEDSmart-BLE2-Relay-1000W	85364900	110x57x37	0,10	694149778284	1

Tekniset tiedot

Polttoikä (h) (L70)	100.000 h
Polttoikä (h) (L80)	70.000 h
Polttoikä (h) (L90)	50.000 h
Päälle-/poiskytkentöjä	100.000
Väriyhtenäisyys (SDCM)	3
Himmennettävyyys	BLE2
Säteilykulma	90°
Väri	Valkoinen RAL9003
UGR	≤ 19
IP etupuoli	IP54
IP upotettu osa	IP20
Iskunkestävyysluokka	IK03
Suojausluokka	II
Risk group (EN 62471)	RG0
Sisältää ohjauslaitteen	Kyllä
Hehkulankatesti	650°C
Tehokerroin	≥ 0,9

Sähkönsyöttö

Taajuus	50/60 Hz
Nimellisjännitealue	220-240 V
DC input voltage	Katso luettelon liite, Liitântätiedot
230 V: n kaapelin pituus	1 m

Mekaaniset ominaisuudet

Kotelon/suojausmateriaali	alumiini
Optinen materiaali	PMMA
Suojausmateriaali	polystyreeni

Käyttöolosuhteet

Toimintalämpötila	-10-+45°C
Käyttölämpötila	+25°C
Varastointilämpötila	-20-+50°C



Mittapiirustus (mm)

LEDPanelS-P6 Re295

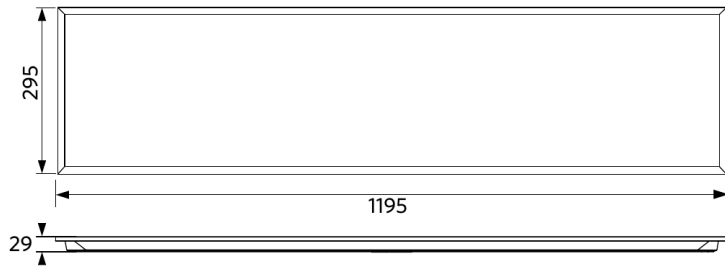

LEDPanelS-P6
Driver On/Off

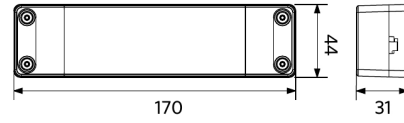

LEDPanelS-P6
Driver Dim

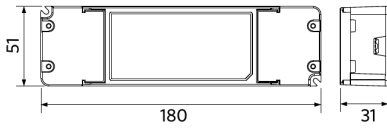

LEDPanelS-P6
Driver Tunable White



Fotometriset tiedot

