



Downlight Performer MW

- Advanced high quality LED downlight
- Unique optical lens concept with matte white (MW) reflector and low glare
- Direct replacement for compact fluorescent downlights - saving over 60% of energy costs
- IP44 on light emitting side
- Provided with protective foil in order to protect the optics against dust and dirt during the installation



Tuotetiedot

Tuotekoodi	Tuotenimi	Vastaava hehku-lamppu	Teho (W)	Valovirta (lm)	Valotehokkuus (lm/W)	UGR	Valonväri (K)	Colour rendering index CRI	Paino (kg/kpl)
540001087800	LEDDownlightRc-P-MW R200-15W-BLE-940	CFL 1x26W	15	1650	110	≤ 19	4000	≥ 90	0,83

Available on request with 3- or 5- or 3+2 pole Wieland GST18i or Wago WINSTA connector. BLE versions are not compatible with surface module accessories.

Varusteet



140060647
LEDDownlightRc-P-SI-E-Adapter-200-225

140060648
LEDDownlightRc-P-SI-E-Adapter-200-250



140061243
LEDDownlightRc-P-R200-Surface-Module-WH



549098001300
LEDDownlightRc-P EM-kit 1h

549098001400
LEDDownlightRc-P EM-kit 3h



542098030700
Junction-Box-WH

Pakkaustiedot

Tuote		Pakkaus			
Tuotekoodi	Tuotenimi	Mitat (mm) (PxLxK)	Bruttopaino (kg)	EAN	kpl / laatikko
140060647	LEDDownlightRc-P-SI-E-Adapter-200-225	250x250x0.8	0,11	6956321894139	1
140060648	LEDDownlightRc-P-SI-E-Adapter-200-250	275x275x0.8	0,18	6956321894146	1
140061243	LEDDownlightRc-P-R200-Surface-Module-WH	277x277x240	2,41	6956321841416	1
140063563	LEDSmartlight-Rc-Sensor	100x100x70	0,19	6956321862602	1
140063564	LEDSmartlight-Switch	89x21x101	0,09	6956321862619	1
506006003100	LEDSmart-Relay-500W	37x110x57	0,10	6956321820824	1
540001087800	LEDDownlightRc-P-MW R200-15W-BLE-940	260x260x118	1,07	6941408832142	1
542098030700	Junction-Box-WH	43x103.4x26	0,07	6941408868684	1
549098001300	LEDDownlightRc-P EM-kit 1h	490x390x150	0,98	6941497709592	1
549098001400	LEDDownlightRc-P EM-kit 3h	490x390x150	1,08	6941497709585	1
560000005700	Smart Connect Box	100x60x105	0,33	6941497711663	1
560000008400	LEDSmartlight-Rc-MW-Sensor	110x110x75	0,19	6941497726995	1
560098000600	LEDSmart-Sensor Surface-Module-WH	330x220x255	0,15	6941497703972	1

Tekniset tiedot

Lifetime (L70)	70.000 h
Lifetime (L80)	50.000 h
On-/Off-cycles	100.000
Colour consistency (SDCM)	3
Dimmability	BLE
Beam angle	70°
Finishing	White RAL9003
IP front side	IP44
IP recessed part	IP20
Impact strength	IK02
Protection class	II
Risk group (EN 62471)	RG0 / RG1 (23W & 33W)
With control gear	Yes
Glow wire test	650°C
Driver failure rate (at 5,000 hrs)	1 %
Power factor	≥ 0,9

Sähkösyyttö

Frequency	50/60 Hz
Nominal voltage	220-240 V AC
DC input voltage	See catalogue Technical Data section
230V Cable length	0.3 m

Mekaaniset ominaisuudet

Material housing	Die-casted Aluminum
Optical material	Polycarbonate

Käyttöolosuhteet

Operating temperature	-10-+40°C
Application temperature	+25°C
Storage environment	-25-+50°C



Mittapiirustus (mm)

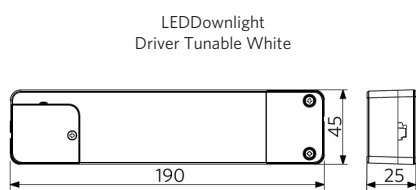
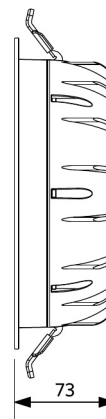
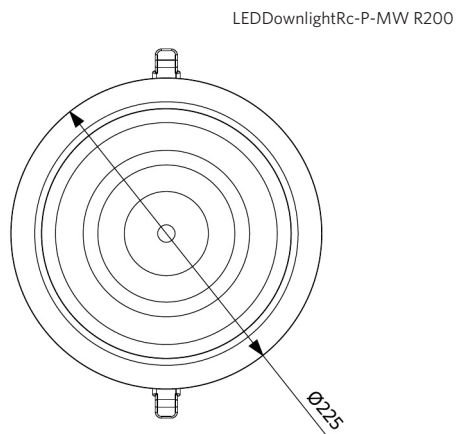
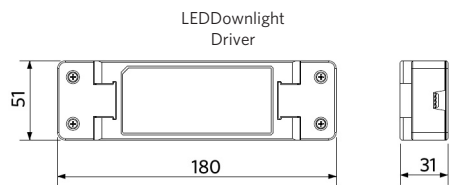

LEDDownlightRc-P-R200-Surface-Module

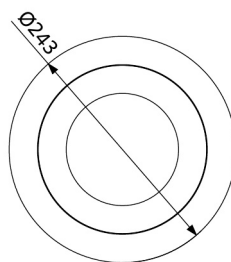
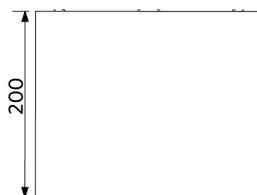

Fotometriset tiedot

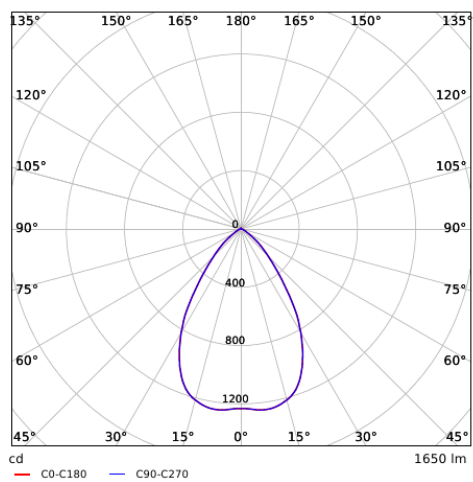

Asennusaukko (mm)

LEDDownlightRc-P-MW R200
Ø200

